

# LCS 3

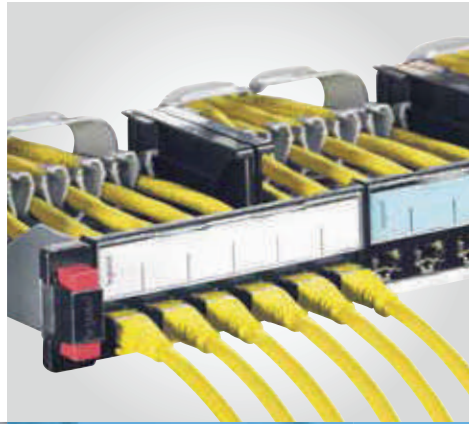

## 3 DIMENSIONS OF EXCELLENCE

◆ PERFORMANCE ◆ SCALABILITY ◆ EFFICIENCY

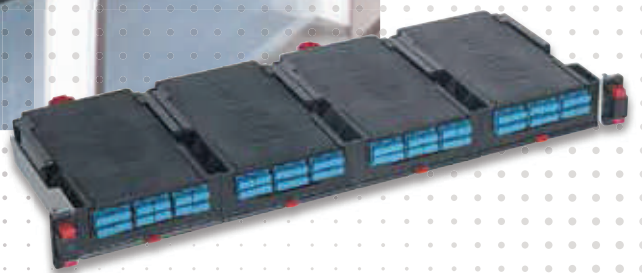

---

DATA CENTER  
LOCAL AREA NETWORK

THE GLOBAL SPECIALIST  
IN ELECTRICAL AND DIGITAL BUILDING INFRASTRUCTURES

 **legrand**<sup>®</sup>

LIVE THE ADVANTAGE

# LCS

3

3 DIMENSIONS  
OF EXCELLENCE

● PERFORMANCE ● SCALABILITY ● EFFICIENCY





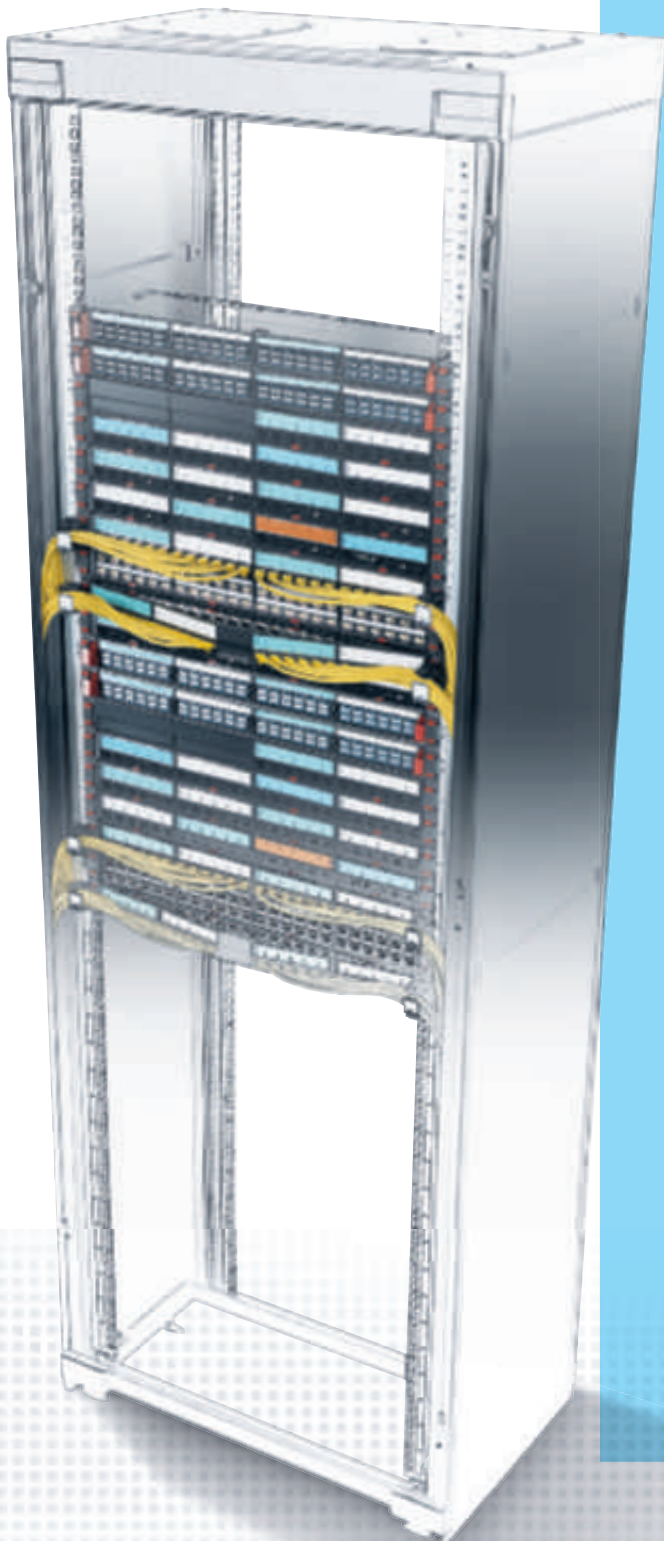

# 3 DIMENSIONS OF EXCELLENCE

● PERFORMANCE ● SCALABILITY ● EFFICIENCY

## CONTENTS

- 4 Legrand - A global player
- 6 Legrand Group - A leading company for all your IT networks
- 8 Our digital infrastructure expertise
- 10 High Performance
- 20 Scalability & Maintenance
- 30 Efficiency
- 32 Easy installation
- 34 LCS<sup>3</sup> Data Center - Enclosure & aisle containment
- 38 Aisle Containment performance, efficiency & scalability
- 42 Micro data center
- 43 Local Area Network
- 44 PDUs - Solutions for any configuration
- 46 Cord Locking System - Innovation at the heart of PDUs
- 48 ZERO-U PDUs - Innovation & performance
- 50 1U PDUs - Innovation & Convenience
- 52 Protection accessories
- 54 Support you can rely on
- 56 Evolution of standard 11801 Edition 3 – 2017
- 58 CAT. 8 - Understanding the new performance category for balanced twisted pair cable
- 62 Fibre optic system - Transmission speed from 40 Gbps to 100 Gbps
- 66 Fibre considerations when migrating to 40/100 Gigabit Ethernet
- 70 CPR – Construction Products Regulation



LCS

3

3 DIMENSIONS  
OF EXCELLENCE

● PERFORMANCE ● SCALABILITY ● EFFICIENCY

# Legrand

## A global player

Legrand is the global specialist in electrical and digital building infrastructures. The Group offers a comprehensive range of solutions and services tailored to residential,

commercial and industrial applications. The scope of its offering and its leading positions make Legrand a worldwide benchmark.



### 4 KEY AREAS of expertise

From control and connection interfaces to cable management, energy distribution and data distribution systems, Legrand provides a host of solutions designed to manage lighting, energy, networks and building access.

AN ACTIVE INTERNATIONAL PRESENCE

ESTABLISHED  
IN OVER  
90 COUNTRIES

SALES IN  
CLOSE TO 180  
COUNTRIES

TURNOVER  
€5 BILLION

OVER 36,000  
EMPLOYEES

INNOVATION

4.9% OF SALES  
INVESTED  
IN R&D

A WIDE CHOICE  
OF SOLUTIONS

OVER  
230,000  
CATALOGUE  
ITEMS

80 PRODUCT  
FAMILIES

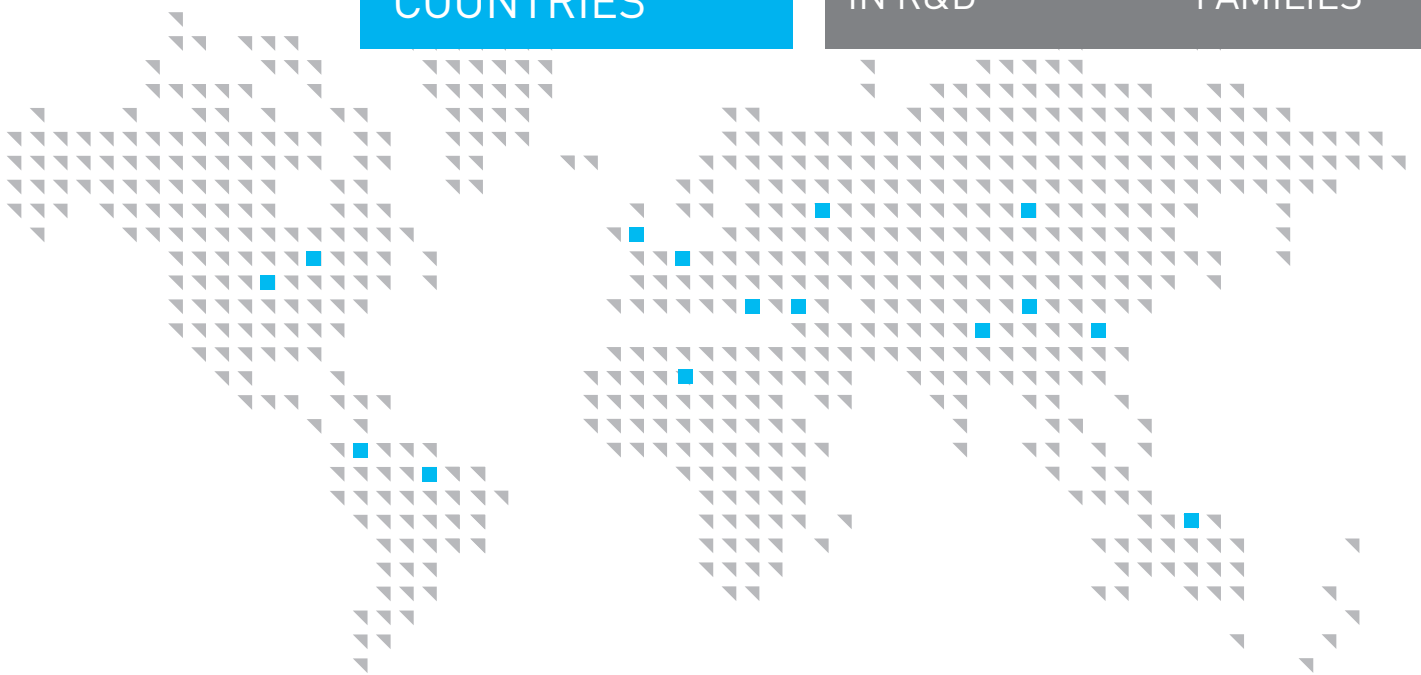

### DIGITAL INFRASTRUCTURE

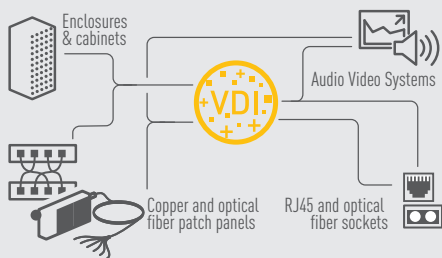

### CONTROL AND COMMAND

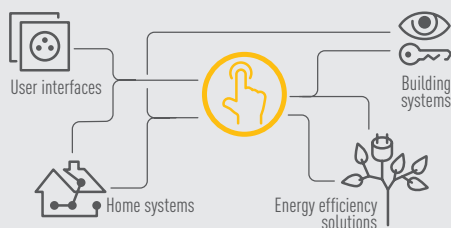

### CABLE MANAGEMENT

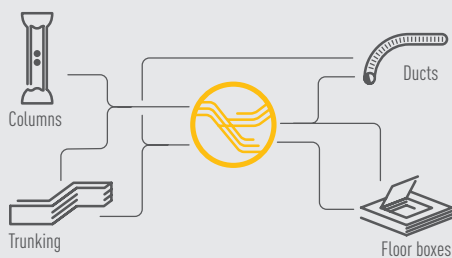

### ENERGY DISTRIBUTION

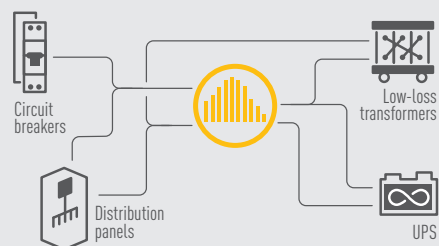



LCS

3

3 DIMENSIONS  
OF EXCELLENCE

● PERFORMANCE ● SCALABILITY ● EFFICIENCY

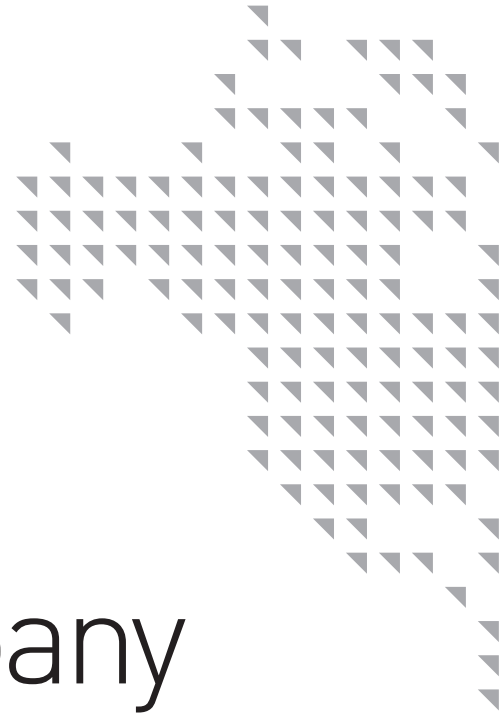

# Legrand Group A leading company for all your IT networks

Legrand cabling systems currently provide high-quality connectivity to more than 200 million devices.

The Legrand Group is a world leader in communication networks for data transmission. Its investment in the

development and design of structured cabling systems and solutions has enabled it to expand its offer and achieve the highest level of performance.

These solutions are ideal for today's multimedia networks, technologies and applications.

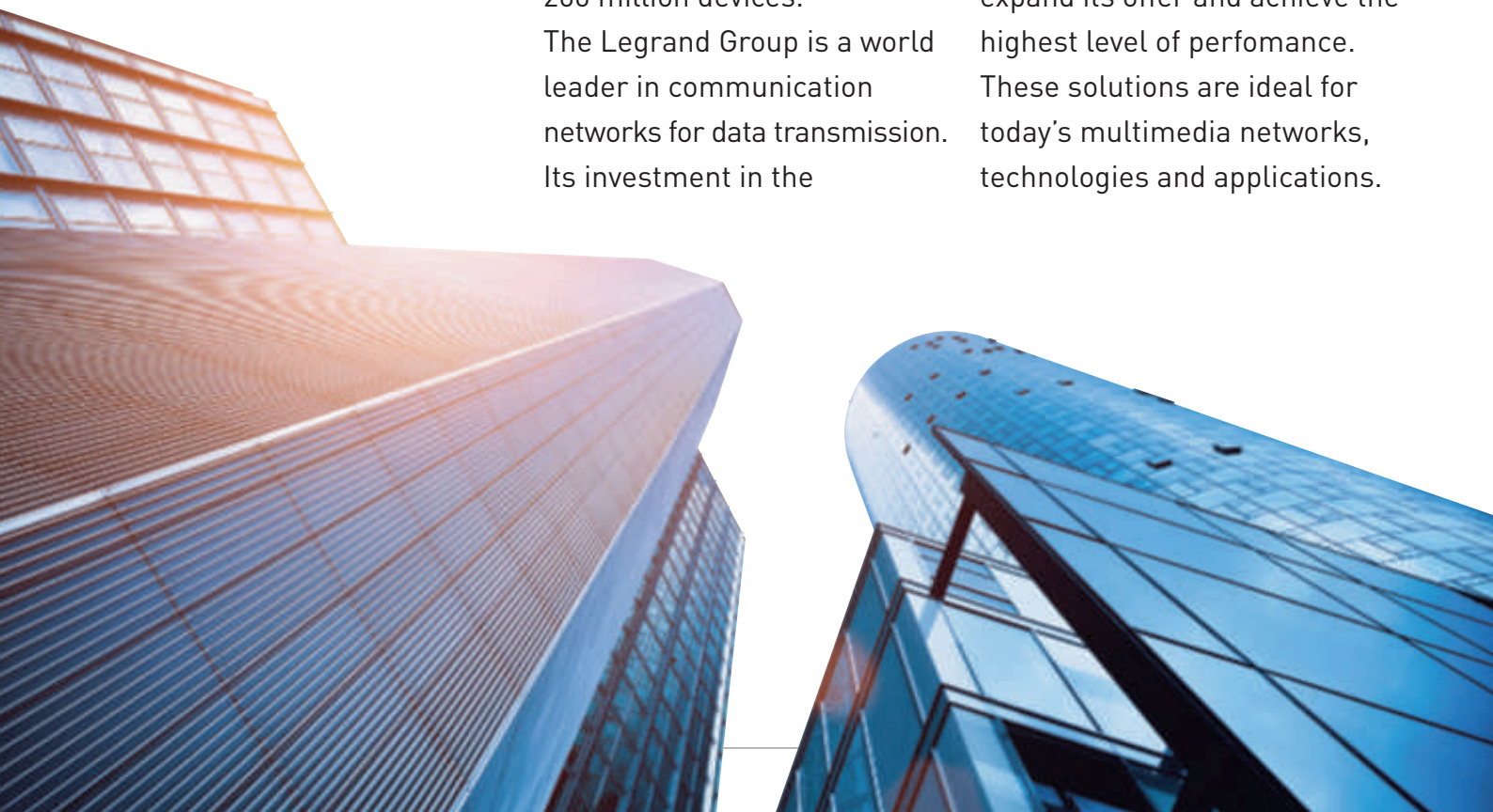



# GLOBAL PLAYERS DATACOM IT

## LEGRAND

Products and systems  
for digital building  
infrastructures.

## A PORTFOLIO OF SPECIALIST BRANDS

- C2G • Electrorack • Estap • Middle Atlantic
- Minkels • Quicktron • Raritan • SJ Manufacturing • Valrack





# Our digital infrastructure expertise

Legrand's complete global solutions for data communication perfectly address the key challenges for digital networks: performance, scalability and efficiency.



## 1

## LOCAL AREA NETWORKS



### SOLUTIONS FOR STRUCTURED CABLING

- **Housing solutions**  
(19" freestanding and wall-mounting cabinets, open racks, PDUs, micro data centers, etc.)
- **Copper solutions**  
(New Plug, controlled-access panel, controlled-access RJ45, etc.)
- **Fibre solutions**  
(Connectors, equipped & modular panels, bend-insensitive cables, etc.)





## 2

### DATA CENTER & SERVER ROOM

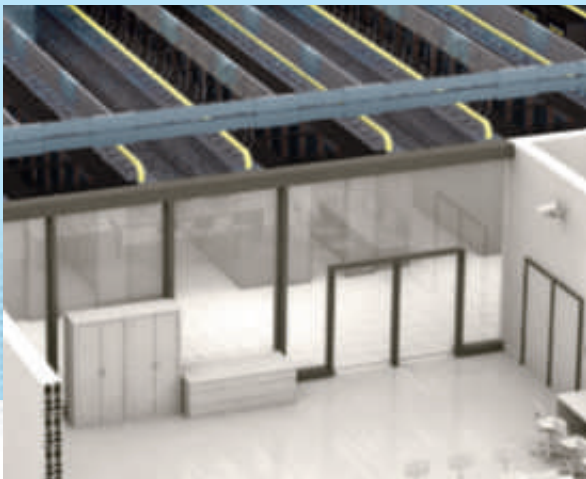

#### SOLUTIONS FOR STRUCTURED CABLING IN SERVER ROOMS

- **Housing solutions**  
(Server cabinets, aisle containment, cooling units and cold corridor, open racks, PDUs, etc.)
- **Copper solutions**  
(Preterminated, etc.)
- **Fibre solutions**  
(Preterminated, intelligent patching, high-density fibre optic solutions, etc.)



## 3

### AUDIO VIDEO SYSTEM



#### A WIDE RANGE OF TECHNOLOGIES TO SUIT THE LOCATION AND THE USER EQUIPMENT

- **Racks and enclosures**
- **Preterminated audio/video sockets**  
(HDMI, display port, HD15, USB, RCA, JACK, etc.)
- **Cords and adaptors**



# HIGH Performance

Legrand's LCS<sup>3</sup> system offers you

- 1 25 Gbps and 40 Gbps Ethernet applications  
**COPPER SYSTEM**
- 2 40 Gbps and 100 Gbps Ethernet applications  
**FIBRE OPTIC SYSTEM**
- 3 MTP/MPO high density and up to Cat. 8 solutions  
**FIBRE OPTIC & COPPER SYSTEMS**

# FIBRE OPTIC SYSTEM

MTP/MPO solution transmission up to 100 Gbps



High density connection with 12 or 24 fibres compliant with IEEE 802.3ba.



**New MPO/MTP** fibre optic drawers. Up to 96 LC on 1U. Easy access in order to move, add & change fibres.



Up to 144 LC on 1U. Available in 1U, 2U and 4U.

# COPPER SYSTEM

Cat. 8 transmission up to 40 Gbps

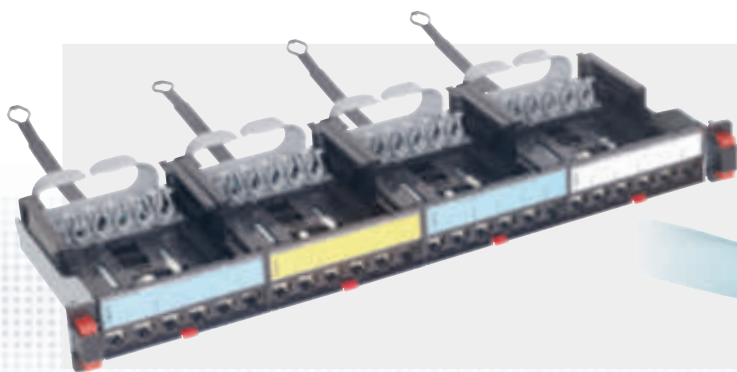

Cable & connector compliant with ISO/IEC 11801 standards - third edition.

**Cat. 8 toolless connector:** up to 2500 connection/disconnection cycles

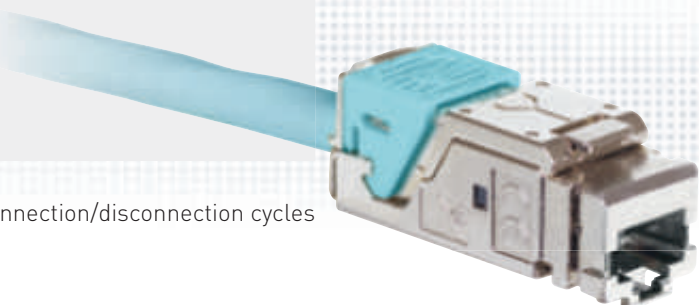





COPPER SYSTEM

# Optimum performance with Cat. 8

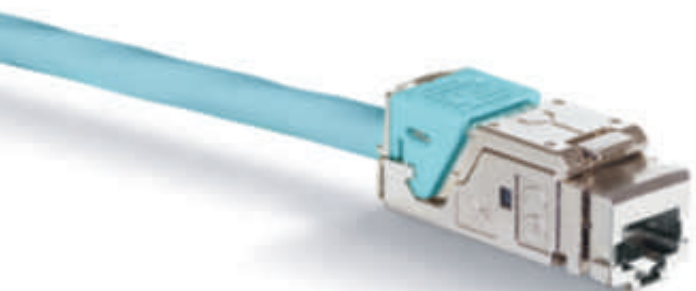
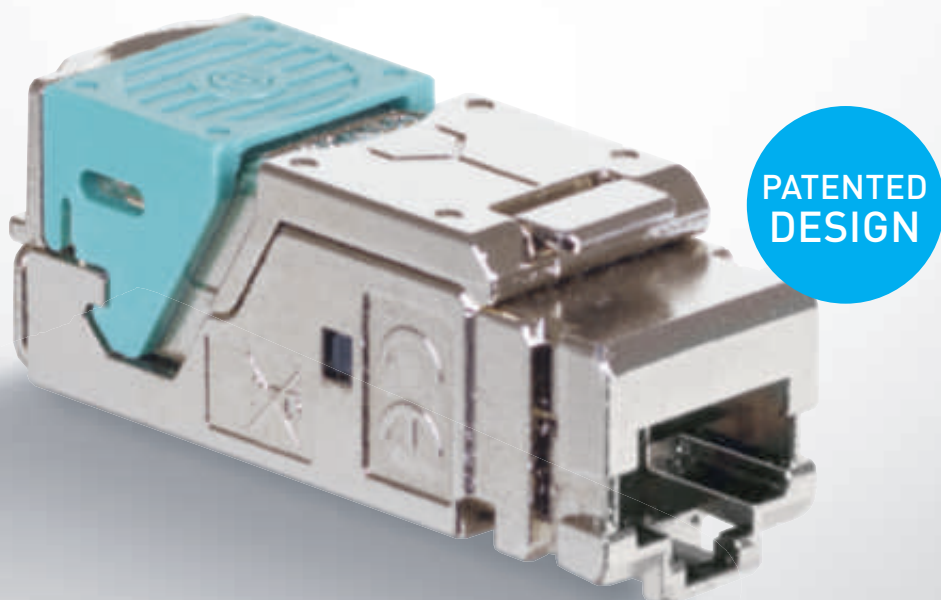

#### **THE NEW toolless Cat. 8 STP CONNECTORS**

with transmission speed (bit rate) from 25 Gbps to 40 Gbps, are integral to the performance of the new LCS<sup>3</sup> system.

- In accordance with ISO/IEC 11801 standard - third edition
- Tested up to 2500 connection/disconnection cycles
- A perfect connection in just a few seconds

**To maximise performance, combine the Legrand Cat. 8 connector together with the Legrand Cat. 8 cable supporting up to 40 Gbps over a single cable.**

The Cat. 8 cable is terminated with an improved dedicated RJ45 connector which can support future performance.

The performance is 4 times better than that of a Cat. 6A cable with up to 2000 MHz bandwidth.

- Double screening to avoid interference and loss of data
- Dedicated to higher capacity in data centers and equipment rooms
- Compliant with ISO/IEC 11801 standard - third edition

## Legrand cable solutions

	Supported network protocol	COMPONENT SIZES				LINK SIZES (CHANNEL)			
		Cat. 8 STP	Cat. 6A STP	Cat. 6 UTP	Cat. 6 FTP	Class I	Class E <sub>A</sub>		Class E
		2000 MHz	500 MHz	250 MHz	250 MHz	2000 MHz	500 MHz	250 MHz	250 MHz
		40 Giga	10 Giga	1 Giga	1 Giga	40 Giga	10 Giga	1 Giga	1 Giga
Attenuation (dB) Signal loss	LCS <sup>3</sup> ISO 11801 Edition 3	1.5	0.13 0.45 max	0.06 0.32 max	0.09 0.32 max	32.7	35.4 42.1 max	24.1 29.9 max	25.7 30.7 max
Return loss (dB) Resistance to echo	LCS <sup>3</sup> ISO 11801 Edition 3	12	17.05 14 min	26.59 20 min	29.8 16 min	8	16.4 8 min	22.1 10 min	38.8 10 min
Next (dB) Resistance to disturbance between pairs <sup>(1)</sup>	LCS <sup>3</sup> ISO 11801 Edition 3	12.9	37.46 37 min	56.93 46 min	51.3 46 min	9.8	38.1 29.2 min	54 35.3 min	53.9 35.3 min

	LCS <sup>3</sup> 8	LCS <sup>2</sup> 6 <sub>A</sub>		LCS <sup>2</sup> 6		LCS <sup>2</sup> 5 <sub>e</sub>
FREQUENCY	2000 MHz	500 MHz		250 MHz		100 MHz
DELIVERY	40 Gbps	10 Gbps		1 Gbps		1 Gbps
WIRING	Copper	Copper	FO	Copper	FO	Copper
CONNECTORS	RJ45	RJ45	SC-LC...	RJ45	SC-LC...	RJ45
MAX. CABLE LENGTH	30 m	100 m	variable	100 m	variable	100 m

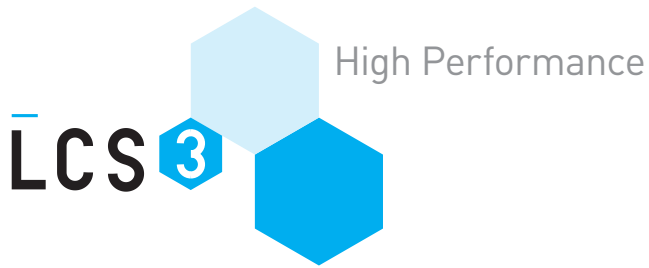

COPPER SYSTEM

# All the LCS<sup>3</sup> connectors are PoE+ certified and ready for PoE++

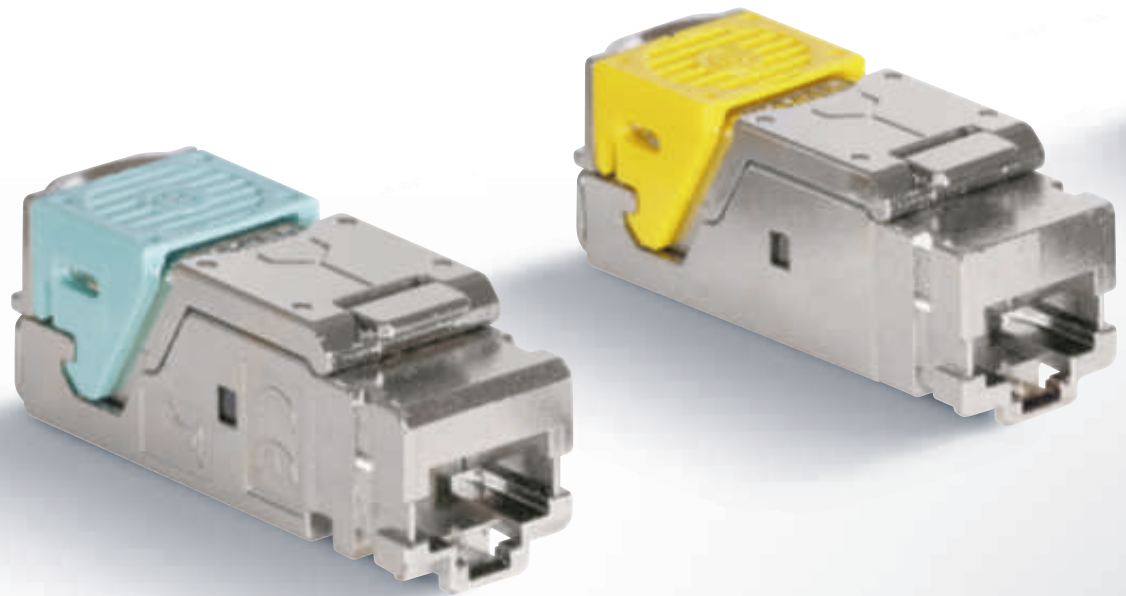

Using PoE technology, devices such as Wi-Fi access points, cameras, etc. can be supplied with power by the Ethernet data cable. The cable combines data and power to supply all the PoE peripherals. Depending on the power available, there are three levels of PoE:

- **PoE compliant with IEEE 802.3af -2003**
- **PoE+ compliant with IEEE 802.3at -2007**
- **PoE++ compliant with IEEE 802.3bt -2018**





Due to the high power in PoE++ the choice of a high-quality connector is essential. While disconnected, Legrand's high-quality connectors prevent damage to the contacts due to the arc generated.



## PoE++ 802.3bt

Trade name	IEEE standards	Voltage	Current drawn
PoE	802.3af-2003	44-57 V	350 mA
PoE+	802.3at-2009	50-57 V	600 mA
PoE++	pr 802.3bt(*)	50-57 V	600 mA

Trade name	Power injector	Available power	Number of pairs for power supply	Minimum cable category
PoE	15.4 W	12.95 W	2	Cat. 3
PoE+	30 W	25.5 W	2	Cat. 5e
PoE++	100 W	70 W (min)	4	Cat. 5e

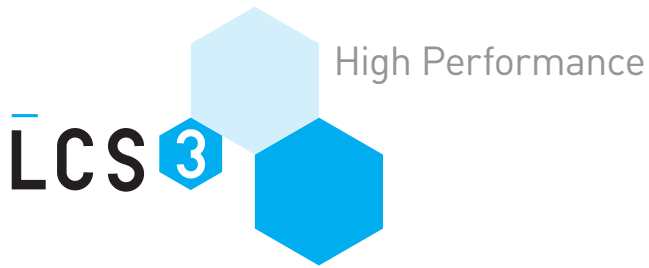

FIBRE OPTIC SYSTEM

# Legrand high-speed solution MTP system

## High-speed solution

With data centers, increased bandwidth has become a priority requirement. The IEEE has therefore introduced the 802.3ba standard for internet connections at 40 Gbps and 100 Gbps and beyond. To answer this need Legrand has introduced the MTP (Multiple-Fibre Push-On/Pull-Off compatible MPO) fibre solution to the catalogue. It guarantees speed, resistance, high performance and high density.



## 40/100 Gigabit Ethernet connectivity and cable



With the need to support multiple transmission paths, the MPO-style connector is the connector identified by the IEEE 802.3 ba standard for 40G & 100G transmission (when not using WDM). The terms "MPO" and "MTP" are used interchangeably for this style of connector (MPO = generic name). MTP is an MPO-style connector and is considered to be a better performing connector with lower insertion loss.

Based on the aforementioned standards, all 40/100 Gigabit Ethernet options over multimode fibre use parallel transmission, requiring more than two fibres per channel.

### MTP connector feature:

- a high-speed connection with 12 fibres (optionally with 24 fibres)
- precise and safe connection
- optimised cable management
- high-density fibres
- scalable system for future upgrades
- simple maintenance operations
- ease of extraction. No complex installation on site - plug and play
- the MTP is a 12-core connector. 1 cable = 1 connector

With standard active equipment, we need to convert the MTP to LC or SC

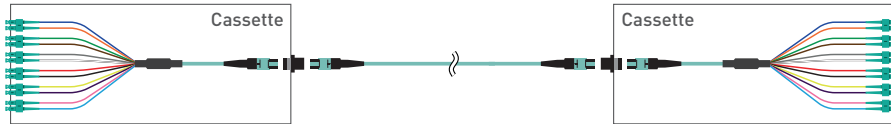

## High performance

MTP/MPO high performance	Multimode high performance	Singlemode high performance
Insertion loss / Master IEC 61300-3-4	Up to 0.1 dB typical (all fibres) Up to 0.35 dB maximum (single fibre)	Up to 0.1 dB typical (all fibres) Up to 0.35 dB maximum (single fibre)
Optical return loss	Not applicable	> 60 dB (8° angle-polished)

The ultra high density connector in our offer is the MTP



## LC® connector

	Multimode high performance	Singlemode high performance
IL Max/Master (Acceptance)	Up to 0.15 dB	Up to 0.15 dB
IL Max/Random	Up to 0.25 dB	Up to 0.30 dB
Ave/Master	0.08 dB	0.12 dB
Ave/Random	0.1 dB	0.12 dB
Return loss	Up to 35 dB	Up to 55 dB



### Common Data Center Approaches

Multimode fibre systems have been the most cost effective fibre solution to use in the data center because the transceivers are much less expensive than single-mode transceivers. Multimode transceivers use a vertical cavity surface emitting laser (VCSEL) light source, which is easy to manufacture and package. Multimode fibre systems have a shorter reach than single-mode systems, however most distances are less than 150 meters; surveys have shown that more than 80% of data centers links are equal to or less than 100 meters. Although single-mode cable is less expensive, factoring in the total system cost of multimode versus single-mode, multimode is still less expensive.

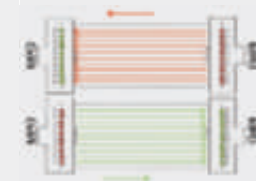
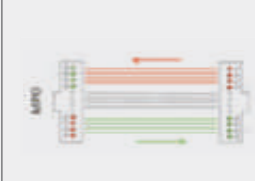
	10G	40G	100G (-SR10)	100G (-SR4)
<b>Signalling</b>	10 Gb	10 Gb x 4	10 Gb x 10	25 Gb x 4
<b>Laser Type</b>	VCSEL	VCSEL Array	VCSEL Array	VCSEL Array
<b>Fibre Type</b>	OM3/OM4	OM3/OM4	OM3/OM4	OM3/OM4
<b>Connector</b>	2 LCs 	12-fibre MPO/MTP 	(2) 12-fibre MPO/MTP or 24-fibre MPO/MTP 	12-fibre MPO/MTP 
<b>Number of Fibres Needed</b>	2 fibres	8 fibres	20 fibres	8 fibres
<b>Maximum Distance</b>	OM3: 300 m OM4: 550 m	OM3: 100+ m OM4: 150+ m <sup>1</sup>	OM3: 100+ m OM4: 150 m <sup>1</sup>	OM3: 70 m OM4: 100 m

1. 150 metres on OM4 requires low-loss connectors. This is discussed in the channel insertion section.

## High performance on all standard and on-demand preterminated systems

Connectivity	TYPES							
Trunks	Tight buffer	Loose tube	Loose tube corrugated steel tape	Break-out	Fan-out	Micro-cable 250 microns	Cassette	Cassette Fan-out
	<b>TYPE OF FIBRE</b> OS1/OS2, OM1, OM2, OM3, OM4, OM5, etc.			<b>NUMBER OF FIBRES</b> 2, 4, 6, 8, 12, 16, 24, On demand, etc.		<b>CHOICE OF TERMINATION</b> LC, SC, SC APC, MTP etc.		<b>PLEASE CONTACT US</b> for any specific requirements.
Cabling	High density (HD)				Ultra high density (UHD)			
Panels & cassettes Splice panel	<b>MTP to LC or SC. Cassette to cassette without MTP</b>				<b>MTP to LC</b>			
Cables/Patch cords	OM2, OM3, OM4 & OS2 Microcable loose tube							

## What's coming

IEEE has a number of ongoing projects for both copper and fibre optic applications. The wideband multimode fibre optic (WMMF) TIA & 11801-1 standards were approved for publication in the middle of 2016. ISO/IEC 11801-1 assigned the OM5 designation for this type of fibre. The standard specifies high bandwidth 50 microns core diameter/125 microns cladding diameter, laser-optimised optical fibre that is optimised to enhance performance for single wavelength or multiwavelength transmission systems with wavelengths in the vicinity of 850 nm to 950 nm.

Transmission	40 GbE Tx Rx	100 GbE Tx Rx	400 GbE Tx Rx
10G parallel channels			Not applicable
25G parallel channels	Not applicable		
10G or 25G with WDM and/or parallel channels			

**Note:** Multiple lines represent parallel channels and with multiple colours represents WDM (multiple wavelength within the same channel).  
 WBMMF (OM5) is coming to be an option for reducing the number of fibres that need to be deployed (100G and 400G)

# LCS

3 DIMENSIONS  
OF EXCELLENCE

● PERFORMANCE ● SCALABILITY ● EFFICIENCY

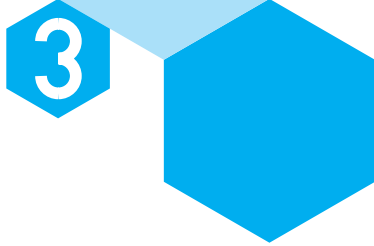

- 1 SLIDING CASSETTE:  
EASIER MAINTENANCE
- 2 INNOVATIVE MODULAR  
CASSETTE SYSTEM
- 3 FAST PUSH-BUTTON  
EXTRACTION

# Scalability & Maintenance

## COPPER SYSTEM RJ 45 Connectors

The **NEW TOOLLESS CONNECTORS** with toolless fast connection are available in all categories for installation both on patch panels and in the workstation. A perfect connection can be obtained in a few seconds, guaranteeing optimum performance of the link from the patch panel to the workstation. They are colour-coded so their category can be safely identified:

- Cat. 5e: grey
- Cat. 6: blue
- Cat. 6 A: yellow
- Cat. 8: aqua

PATENTED  
DESIGN





New systems to facilitate wiring and installation and increase the data transfer speed with both the copper solution and the fibre optic solution.

## New Toolless connector connection phases

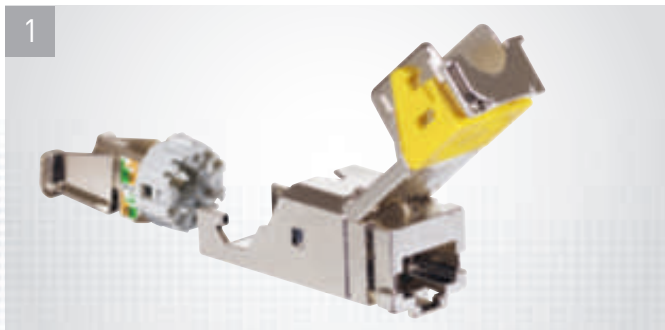

1 Take the wire housing



2 Pass the cable through the back of the wire housing

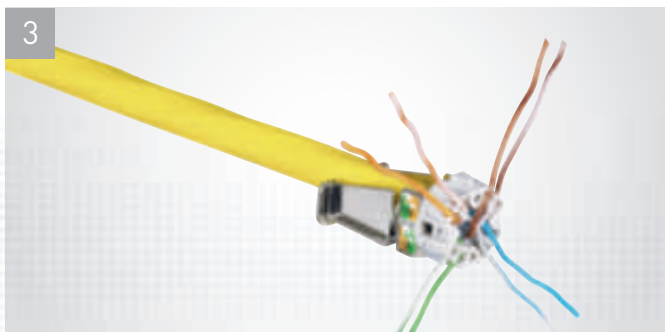

3 Separate and insert the pairs



4 Cut the pairs



5 Install the wire housing without pushing



6 Push down the lever and lock the connector

## Patch Panels

The new patch panels have been designed and produced to optimise space, with up to 48 ports per unit and make maintenance and future upgrades easier. They are available in both flat and angled versions. They have a quick system for pulling out the unit and an innovative cable guiding system for tidy and easy cable management.

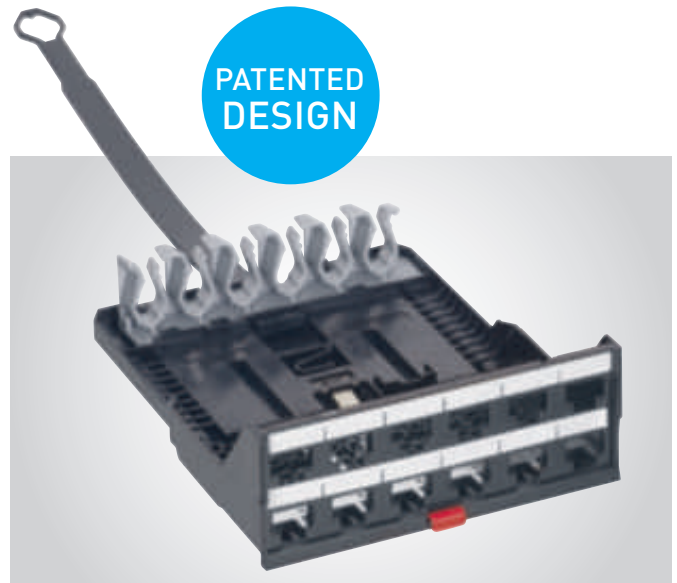

Block of 12 connectors for patch panel

- Sliding cassettes: easier maintenance
- Fast push-button extraction
- Innovative modular cassette system
- Easy maintenance: Remove connectors without disconnecting the cords
- **Easy to mix with Legrand fibre optic solutions**

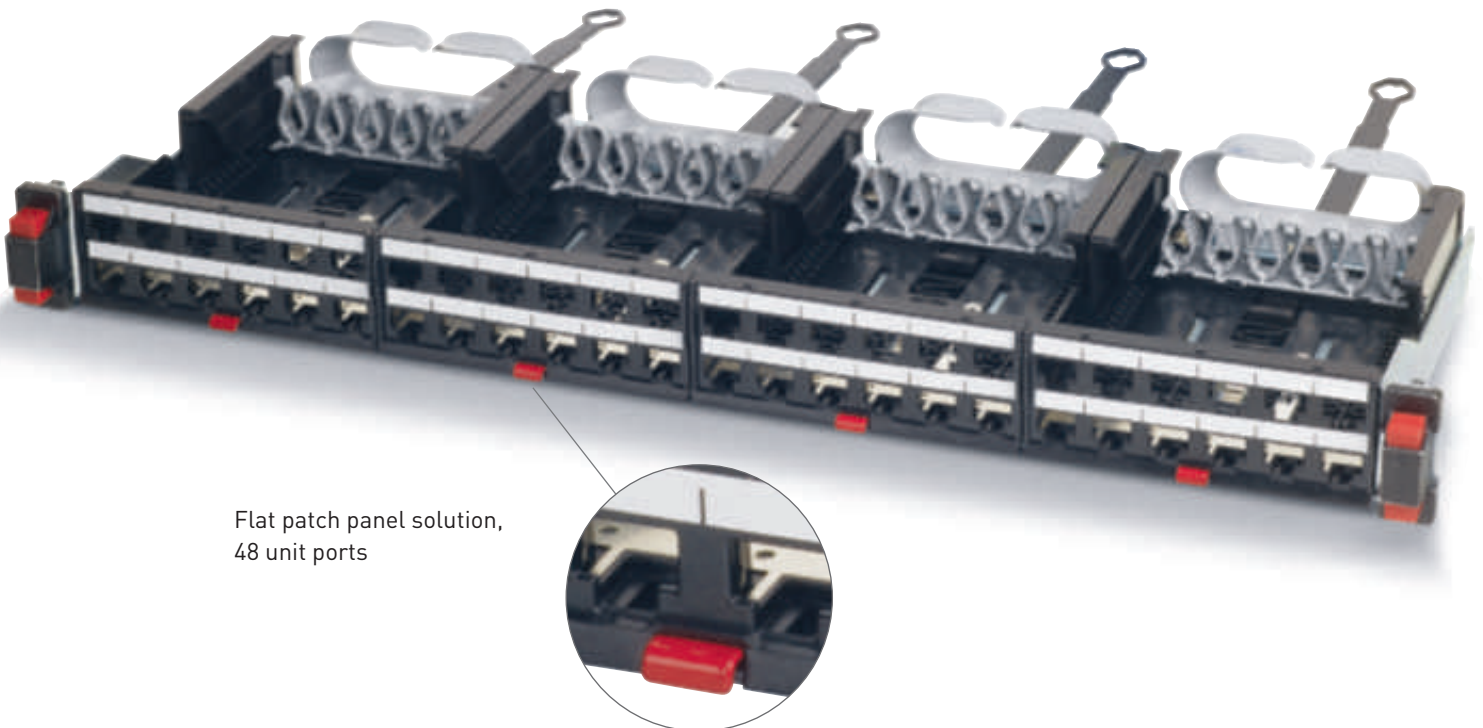

Flat patch panel solution, 48 unit ports

## New QUICK-FIX system

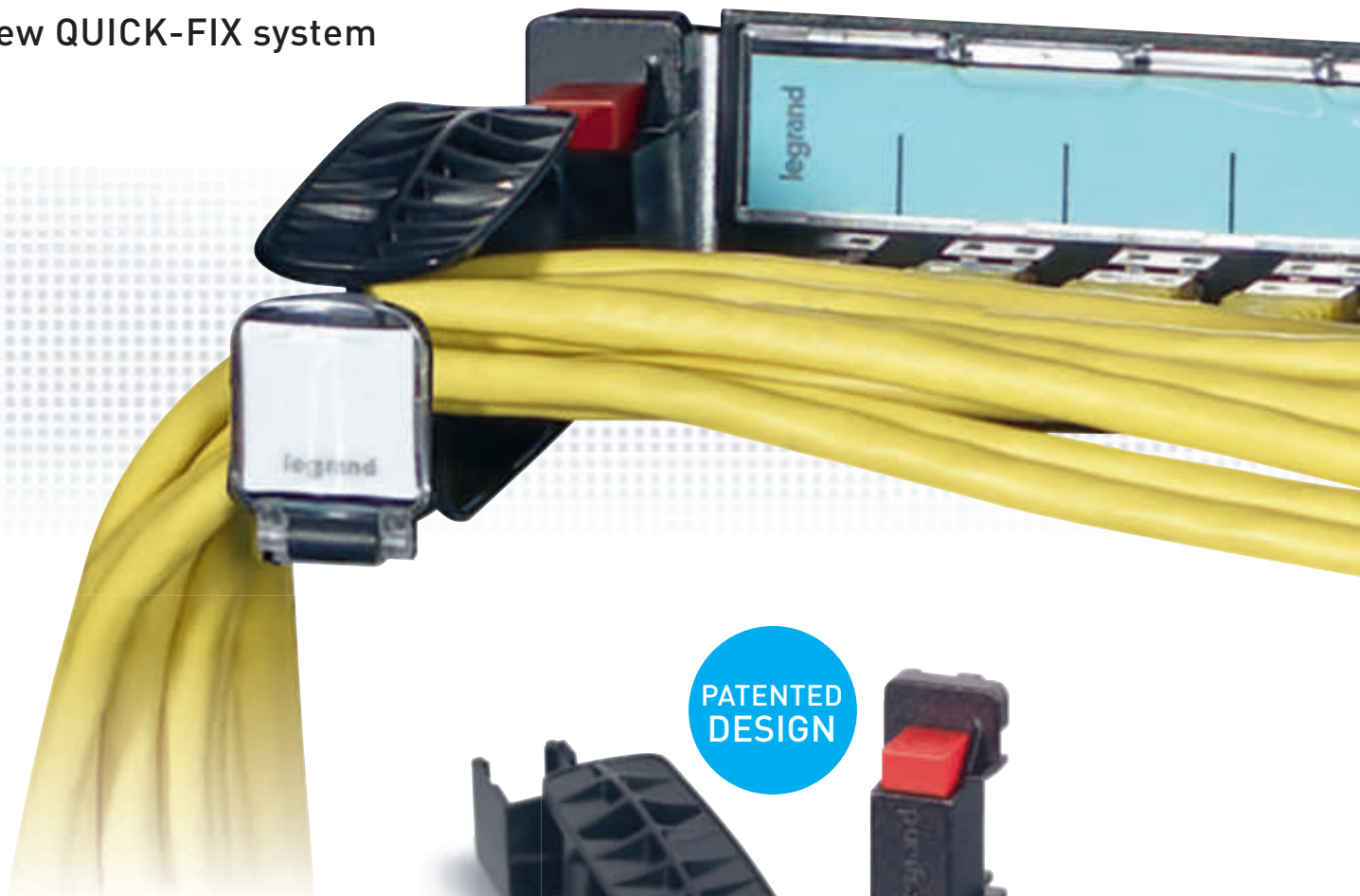

PATENTED  
DESIGN



Innovative new quick-fixing solution:

- Push and connect system
- Automatic earth connection
- In-rack cabling optimised
- New accessory for patch cords with rotating system for angle adjustment and label holder

**Compatible with all panels  
(Flat, angled, HD)**



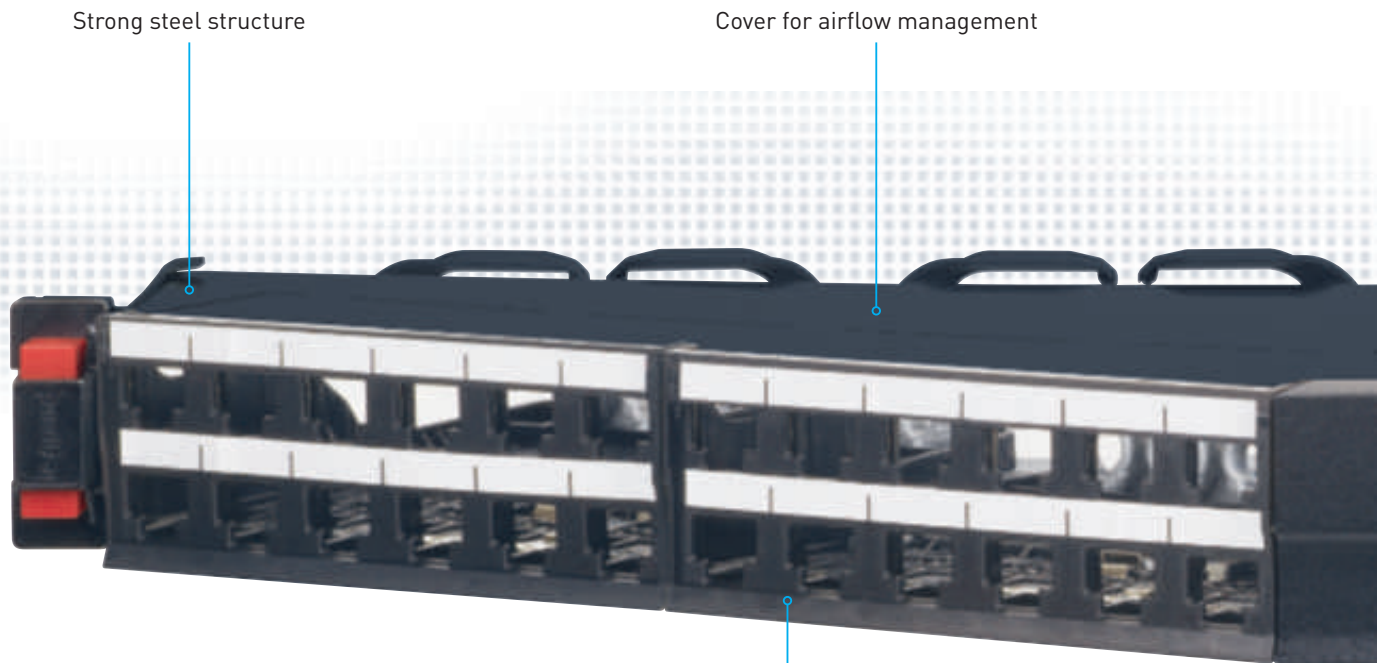

Strong steel structure

Cover for airflow management

High density - This supplies up to 48 ports in a single unit to take up less space in the rack

## Angled patch panel solution from 24 to 48 ports per unit

Patch panels with an angled design which allows the cable to run into each side of the rack, creating a correct cable radius of curvature. This avoids the need to manage the cables horizontally, and allows the patch cords to be carried directly in the vertical cavities.





Tidy cable management

Quick-fix system



Simple and efficient  
Identification of the ports



Also available  
in the 24-port version



Scalability &  
Maintenance

# Fibre optic panels

Completely renovated and redesigned fibre optic panels & drawers in high and very high density versions from 96 connectors per unit to 144 connectors per unit. Panels with sliding drawers and fast push-button system to facilitate upgrade and maintenance operations.

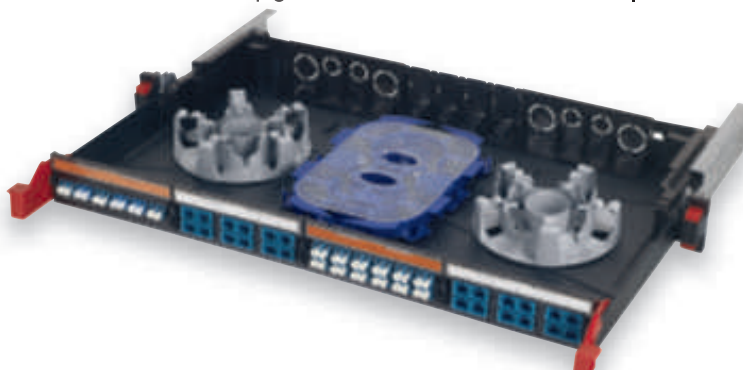

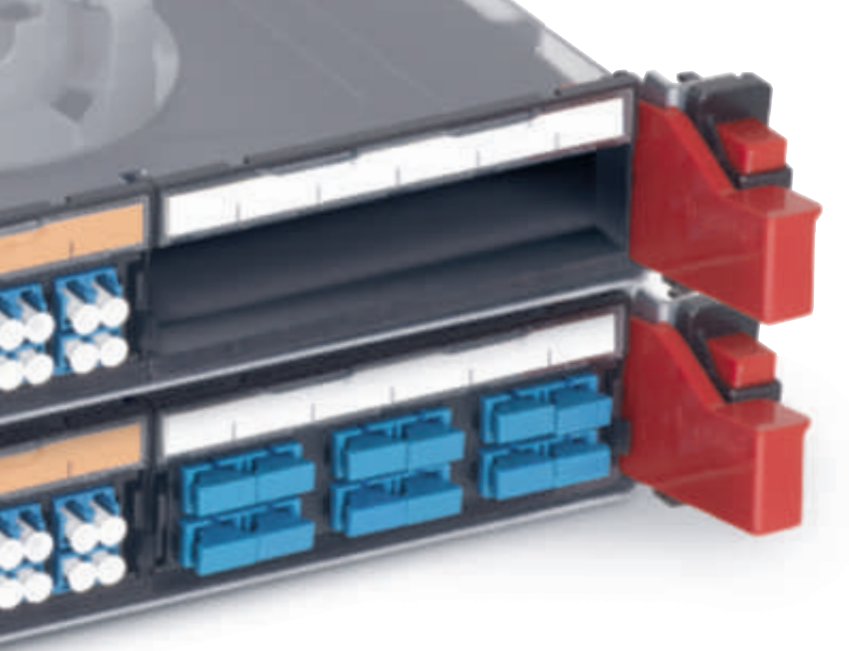

## MODULAR PANELS

- Possible to change modular blocks, blank panel, MTP adaptor
- Splice trays to be added if necessary - up to 4 containing 96 LC fibres

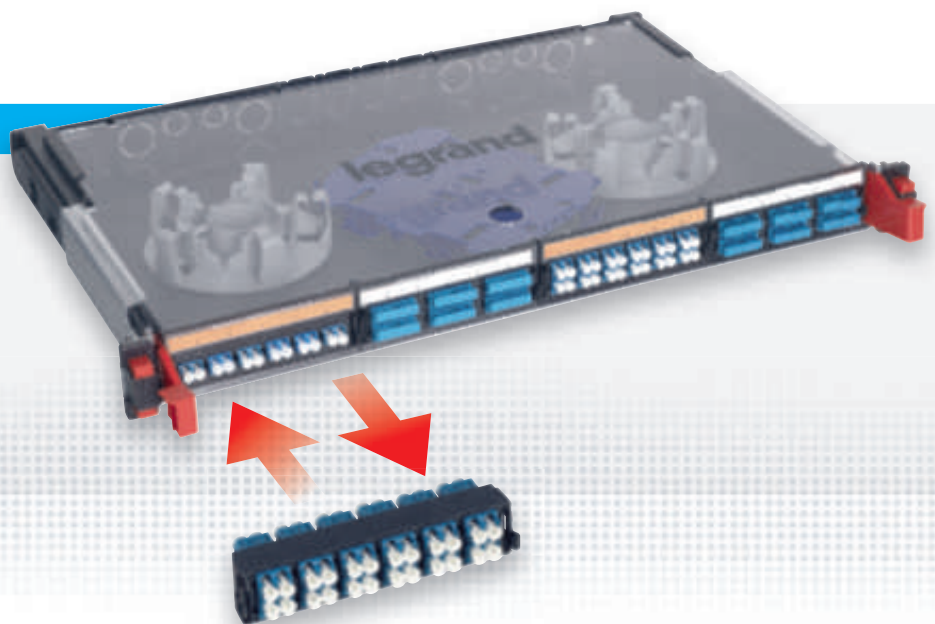

## HD MODULAR PANELS

- Innovative new quick-fixing solution
- Possible to add splicing cassette with perfectly adapted coiling space
- Mixture of fibre/copper on modular panel in drawer

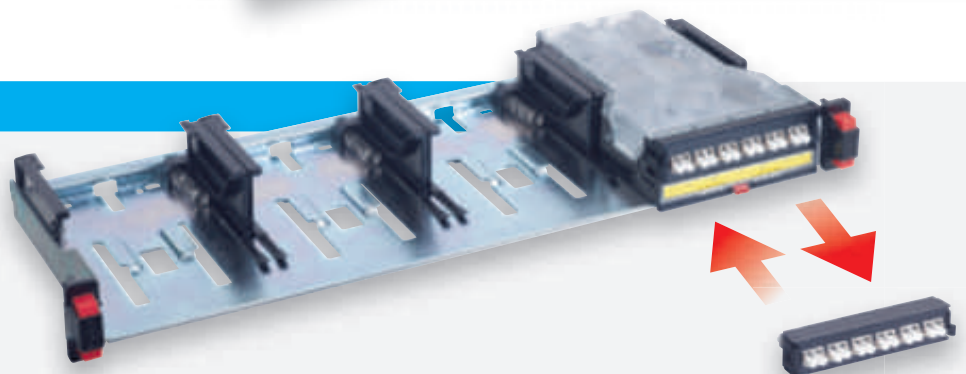



## Fibre optic panels

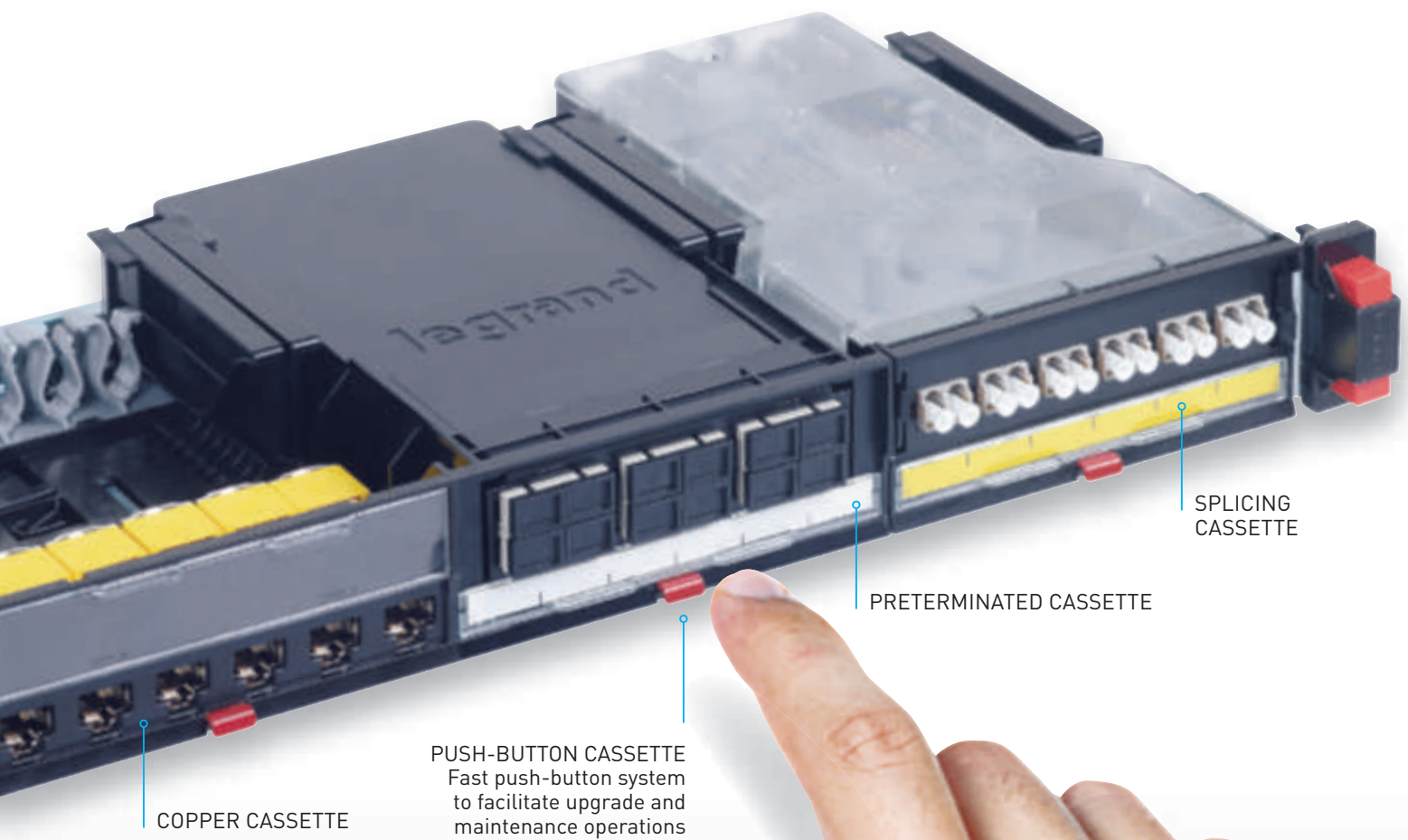





## MODULAR PANELS

- Innovative new quick-fixing solution
- Modular blocks to adapt to modular panel or drawer: LC, SC, ST, LC, APC, SC APC
- Possible to add modular blocks, blank panel, MTP adaptor

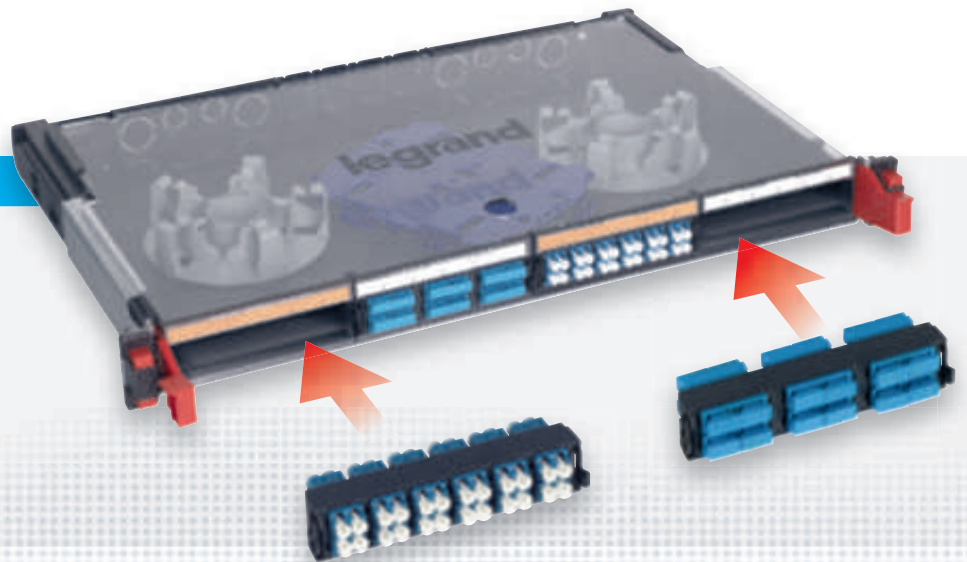

## HD MODULAR PANELS

- Cassettes slide in from front & rear
- Fast push-button on cassette
- Splicing cassette which takes all modular blocks
- Mixture of fibre/copper on cassette panel
- Trunk & cord management system

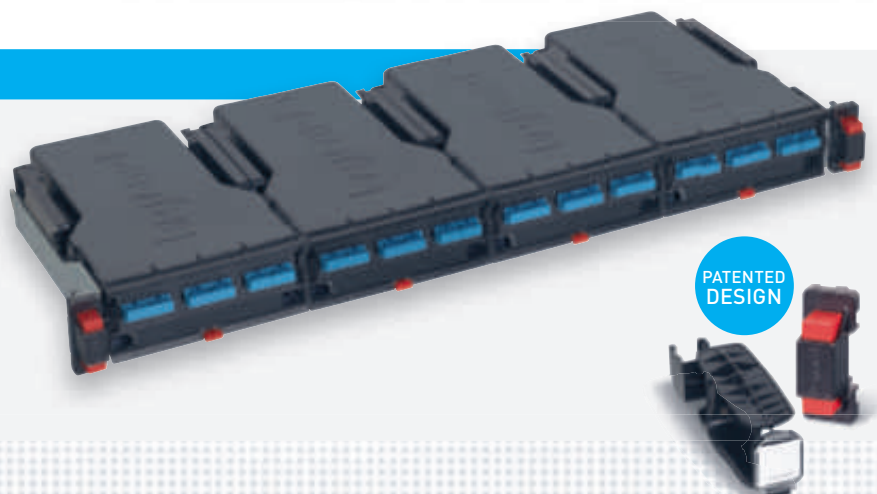





LCS

3

3 DIMENSIONS  
OF EXCELLENCE

● PERFORMANCE ● SCALABILITY ● EFFICIENCY

# EFFICIENCY

## High density

1

48 ports per Unit for high density  
COPPER SYSTEM

2

96 LC per Unit for high density  
FIBRE OPTIC SYSTEM

3

144 LC per Unit for ultra-high density  
FIBRE OPTIC SYSTEM

# COPPER SYSTEM

## Patch panel HD solution up to 48 ports per unit

High-density patch panel. It has changed from 24 to 48 ports, guaranteeing a reduction in space occupied and making future upgrades easier. Designed to house 4 blocks of 12 connectors each.

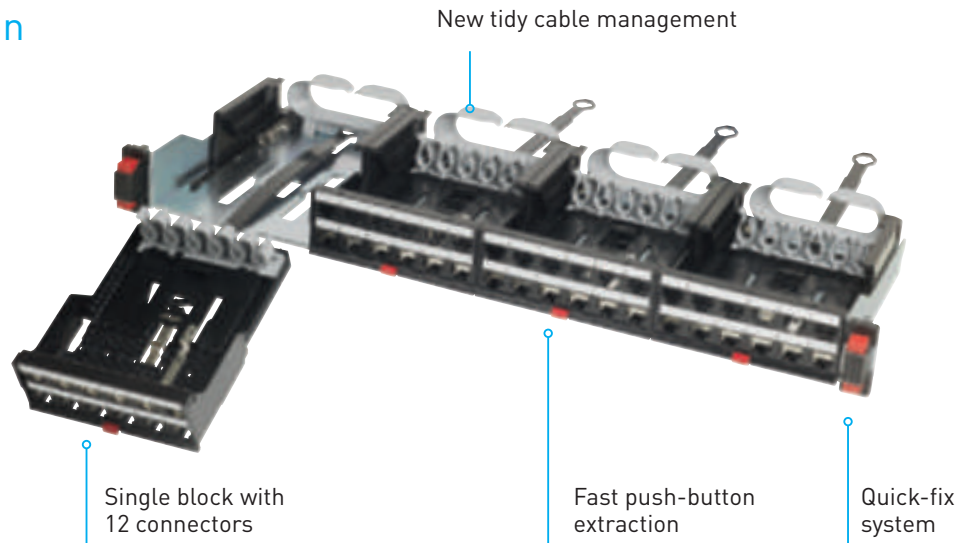

# FIBRE OPTIC SYSTEM

## Very High density up to 144 LC/1U

Since different network architectures such as top-of-rack, end-of-row and middle-of-row require different cabling densities, passive equipment needs to adapt perfectly to the active network. The LCS<sup>3</sup> HD cassette panel provides

a mixed-media structured cabling system to support any configuration. Legrand LCS<sup>3</sup> offers an innovative UHD patch panel designed to house up to 144 connections in 1 U distributed between 6 individual modules of 24 fibres each.

Each module accepts incoming fibres both from MTP® trunk cables and via predetermined components. Predetermined cables are available both as breakout cables and as distribution cables.

### ULTRA HIGH DENSITY UHD



- Up to 144 LC/1U
- 1U, 2U, 4U
- Microcable preterms

### HIGH DENSITY HD



- Up to 96 LC/1U
- Mixture of fibre & copper
- Microcable preterms

Preterminated: The fibre optic cable termination is the addition of connectors to each optical fibre in a cable. The connectors are assembled in our factories





# LCS<sup>3</sup> DATA CENTER

## Enclosure & aisle containment

**Performance,  
scalable & efficient  
solutions**

Legrand LCS<sup>3</sup> has an extensive portfolio of enclosures and aisle containment systems for your data center and/or server room. The Legrand LCS<sup>3</sup> is ideal for the installation of (blade) servers, switches, patch panels, routers and storage equipment. Modularity and flexibility are always key in the design of our products.





## LCS<sup>3</sup> server-and-network rack

The server-and-network racks are versatile and modularly constructed. Which type of rack is most suitable depends ultimately on its application. The server-and-network racks are available in varying heights, widths and depths.

The 600 mm wide rack is a compact rack with a high carrying capacity on a small surface. The 800 mm wide rack is ideal for patching, network and server equipment with enough space for power and network cabling.



### Airflow optimisation

Data centers are increasingly using energy-efficient cooling techniques such as free cooling and fresh air cooling. The first step in this process is separating the warm and cold air using aisle containment solutions. The next step is airflow optimisation in the rack. This step, however, is often not fully or effectively

implemented, although it is the next step in energy-efficient data centers. Airflow optimisation is also important for the server, network and storage equipment to work properly, for temperature control and for the general stability of a data center.

Using airflow optimisation you can achieve the highest levels of

airtightness. The side sealing plate and the side sealing panel are covered with foil. Every assembly opening in the side sealing panel is still usable, but all unused openings are sealed with foil to prevent air leakage. The base and roof plates have an identical level of airtightness. Special foam pieces are even placed around the rails on the base.



Cable brush



Cable entry foam



Cable entry plate

## Top-of-rack cabling system



### From building to cabinet

LEGRAND LCS<sup>3</sup> cable trays can be used for optimum guidance of cables to the cabinet. Cable trays are flexible, modular, easily installable and can be integrated seamlessly in the cabinet. Because this cable system is fixed directly onto the cabinets, it becomes independent of its surroundings. Thus, if the data center expands, the cable management can expand with it without requiring any changes to the construction of the building, unlike ceiling anchoring systems.

### From rack row to rack row

Cable bridges can be used for crossing a cold or warm corridor. The cable bridge can be used for both small and wide cable trays. These can also be used in combination with aisle containment. Because cable bridges are telescopic, no sawing is required in the data center. This helps avoid outages of critical equipment.

### From rack to rack

Cable trays can also be used for cabling from rack to rack. In this case cables do not run horizontally through the racks but are guided over the top, across the roof towards the neighbouring racks.

## Cable management

Management solutions within your rack. Structured cabling is important for the reliability and optimum performance of your data

center or server room. Flexibility and accessibility in the case of troubleshooting or expansion is also essential.



### Reliability

Good cable management ensures the equipment's air intake points are kept as clear as possible. This allows sufficient air to pass through to the equipment so that it is cooled well. Proper cooling helps avoid equipment failures and results in longer equipment lifespans.

### Optimum performance

Good cable management ensures that cables do not become damaged or break and that they have the correct radius of curvature. An incorrect radius of curvature reduces the performance of the cable. The radius of curvature must never be less than what has been recommended by the supplier.

### Flexibility and accessibility

Cabling should have a neat and structured appearance. This makes it easy to move or add cables.



# Aisle Containment

Performance,  
efficiency & scalability

## Energy bill savings

By cooling your data center in the right manner, you can significantly reduce your energy spending. Minkels has developed an extensive range of energy-efficient cooling solutions.





### AISLE CONTAINMENT

Aisle containment is the solution to the challenges data centers have faced since day one: the optimisation of cooling and energy efficiency through the separation of hot and cold airflows.

However, this is not the only challenge which data center managers and owners have been confronted with. Because IT equipment has a shorter life cycle, data center managers and owners encounter a higher rate of change in the data center. Traditional aisle containment does not offer the flexibility and modularity needed to deal with this dynamic. In addition, data center managers and owners are increasingly confronted

with systems – such as storage equipment - which do not come in a standard housing and are therefore hard to fit into a traditional aisle containment system. Furthermore, traditional systems do not offer enough options for optimum integration of sensors and so on. The challenges outlined call for aisle containment solutions offering greater flexibility and modularity and better integration options.

With the Next Generation Corridor we offer data center managers and owners ‘future-proof’ solutions which offer the flexibility and modularity needed in order to anticipate the dynamic of the modern data center.



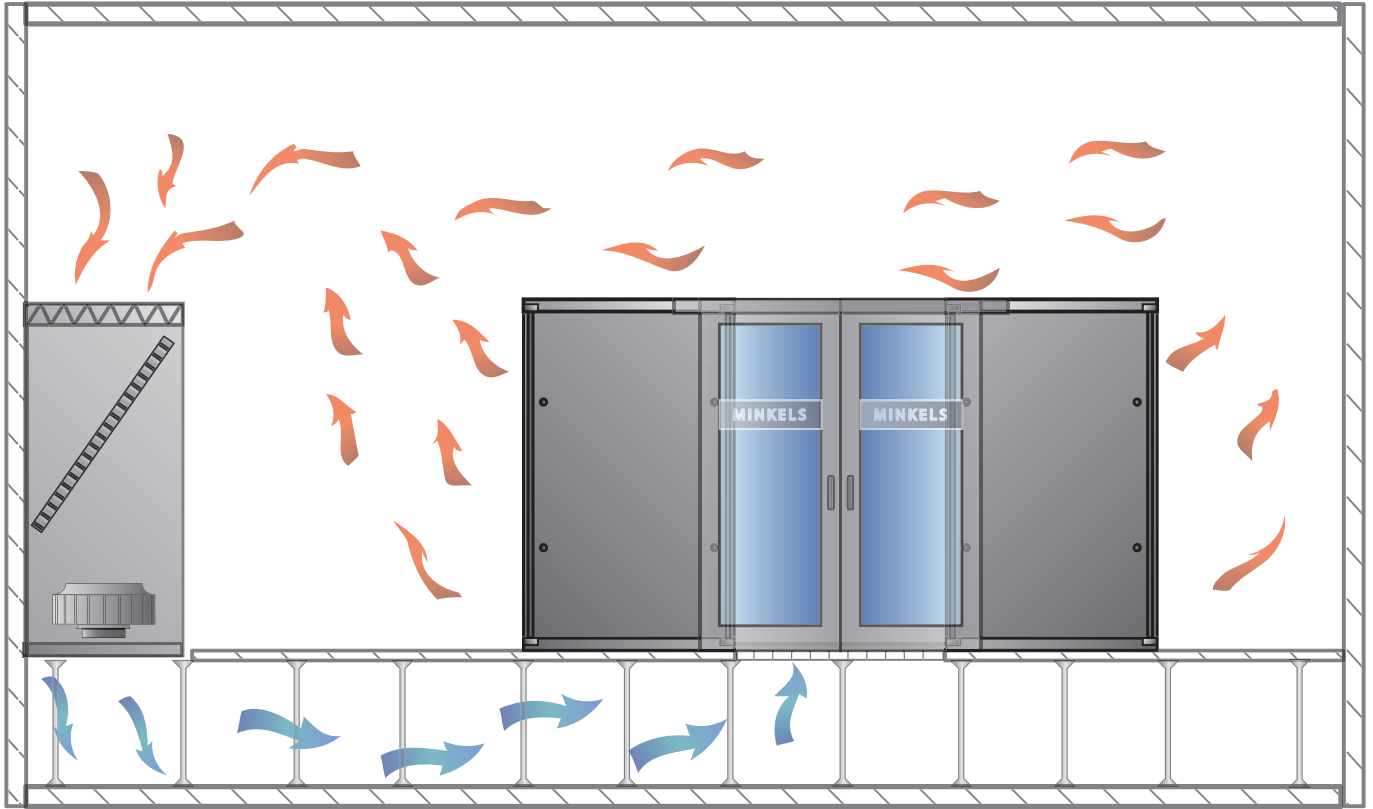

**NEXT GENERATION CORRIDORS  
(rack-dependent)**

Minkels was the first data center supplier in Europe to introduce the Corridor solutions commercially. Since then, these solutions have been used to separate the airflows of many a data center in an energy-efficient manner. Next Generation Corridor is the ultimate answer to the ever-increasing demand for flexible and modular solutions. The Next Generation Corridor takes modular thinking and energy-efficient data center design to a higher level.



Important features of the Next Generation Corridor are:

**MODULARITY**

Through the highly modular concept of the Next Generation Corridor, Minkels offers extensive ways to implement a Corridor solution in a phased and thus cost-efficient manner.

**FLEXIBILITY**

Because of its modular design, the Next Generation Corridor is flexible and thus can be adapted to fit the specific building environment.

**EASE OF INSTALLATION**

Modularity in the construction details ensures that the solution is easily and cost-efficiently installed.

**ENERGY EFFICIENCY**

With the Next Generation Corridor, Minkels offers a solution which is more energy-efficient than other aisle containment models on the market.

**OPTIMUM INTEGRATION**

The Next Generation Corridor can be integrated with row-based cooling systems which bring cooling close

to the heat source, but also with more traditional forms of cooling which require a raised floor. In addition, this concept offers plug & play integration with e.g. fire detection and suppression systems, monitoring sensors and access control.





# Micro data center



## The MiniCube

### Professionalising the IT infrastructure

With the adoption of cloud computing, many companies are now looking to reduce the size of their server rooms and save energy costs. Do you have fewer applications running from your in-house server room than before? Do you only want to house your business critical information on site? Then the time has come to deploy an efficient, turnkey micro

data center. Whether you want to access data more quickly - low latency - or you want to optimise your server room, the MiniCube is the ideal solution. The MiniCube has everything you need for a full data center: housing, power supply, monitoring and cooling, all in a compact system. The MiniCube is fully preconfigured and truly plug-and-play.

### Advantages

- Reliable and efficient solution for server rooms
- No dependency on the building, easy to deploy
- Efficient cabinets or racks for your IT infrastructure
- Use of proven technologies
- Turnkey solution, including installation and start-up

One Catalogue number, one solution





# Local Area Network



## LCS<sup>3</sup> CONNECTIVITY RACK

Mighty Mo 20 4-post racks provide greater flexibility and optimum efficiency in any data center. The fixed racks provide an economical mounting platform for switches and servers while the adjustable rack allows all 4 mounting rails to be adjusted even after the rack has been fastened to the floor.

Front and rear waterfalls allow for equipment patching and server patching. All styles of Mighty Mo 20 vertical manager can be mounted front or rear, and airflow baffles can be mounted to manage the airflow of side-breathing equipment.



## LCS<sup>3</sup> CABLING RACK

Given how quickly IT technology evolves, a flexible, future-proof concept is essential. The LCS<sup>3</sup> cabling rack is specifically designed to meet these needs and stands out due to its versatility, ease of installation and ease of use.

for housing UTP patch panels, glass drawers, telephone panels, switches, routers and other IT equipment. Of course it is also possible to include a small number of servers.

The LCS<sup>3</sup> cabling rack is a multifunctional system, specifically designed for ease of installation. The system is ultimately suitable

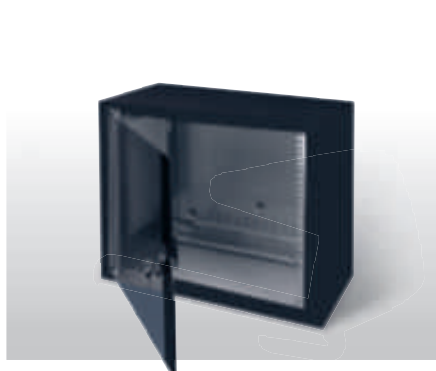

## LCS<sup>3</sup> WALL ENCLOSURE

The basic frame is made up of a wall-mounting plate with integrated strain relief bar, four depth rails, two cable-entry plates (base and top) and a set of 19-inch rails. The assembly consists of two equal top and base panels with ventilation slots to the rear, two equal side panels and a safety glass door with an EK-333 cylinder lock with grip.

# PDU's

## Solutions for any configuration

### A wide universal range

This new PDU offer combines Legrand's quality and innovation with a wide range of applications. A standalone solution, this range integrates seamlessly into any installation and ensures compliance with applicable standards.

#### GENERAL CHARACTERISTICS

- Anodised aluminium body:  
Lightweight rigid high-end material
- Modular design:  
Expandable outlet and function modules

#### SAFETY

- High electrical safety rating
- High-quality connection
- Outlets equipped with safety shutter

#### • Cord Locking System



#### POWER SUPPLY

- 16 A to 32 A single-phase or three-phase
- PDUs integrate local and international outlet types



#### STANDARDS

**IEC 60950** - Information technology equipment – Safety

**IEC 60297-3** - Dimensions of mechanical structures of the 482.6 mm (19 in) series

**IEC 60320-2-2** - Interconnection couplers (C13 and C19) for household and similar equipment

**IEC 60884-1** - Plugs and socket outlets for household and similar purposes (France, Belgium and Germany)

**BS 1363-2** - British standard plugs and socket outlets

**IEC 60309** - Plugs, socket outlets and couplers for industrial purposes

**Certification: CE, TSE, CCC**

**Environmentally-friendly products**

Eco-friendly design



#### ZERO-U PDUs



#### FOR DATA CENTERS/SERVER ROOMS

Used in server cabinets where:

- there is a high density of active equipment
- electrical distribution quality is crucial

#### 12 CATALOGUE NUMBERS

#### FOR VERTICAL INSTALLATION

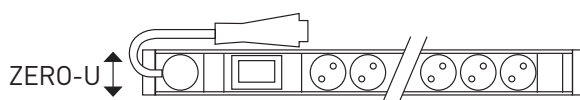

### 19" 1-U PDUs



#### FOR DATA CENTERS/SERVER ROOMS AND COMPUTER ROOMS

Used in server and cabling cabinets where:

- there is a low density of active equipment to be powered
- ease of installation is an advantage

26 CATALOGUE NUMBERS

FOR VERTICAL OR HORIZONTAL INSTALLATION

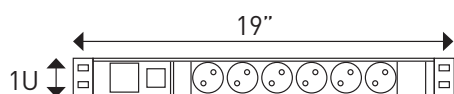

### 10" 1-U PDUs



#### FOR SMALL IT ENVIRONMENTS

Mainly used in small-scale commercial applications where there is a limited number of IT points and a 10" cabinet is sufficient:

- Small businesses, freelance professions, administrative services, etc.

3 CATALOGUE NUMBERS

HORIZONTAL PDU

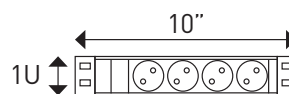



# Cord Locking System

Innovation at the heart of PDUs

For C13 & C19 sockets

A major addition to the range and exclusive to Legrand, C13 and C19 outlets have a power supply cord locking system which prevents accidental disconnection and guarantees absolute safety.

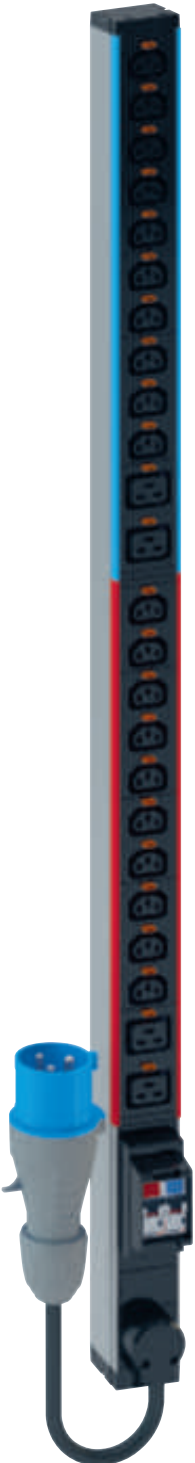

## AN INNOVATIVE TECHNICAL SOLUTION



### **CORD LOCKING SYSTEM**

Very easy to identify thanks to the orange buttons next to each outlet







**1 CONNECTION** ✓

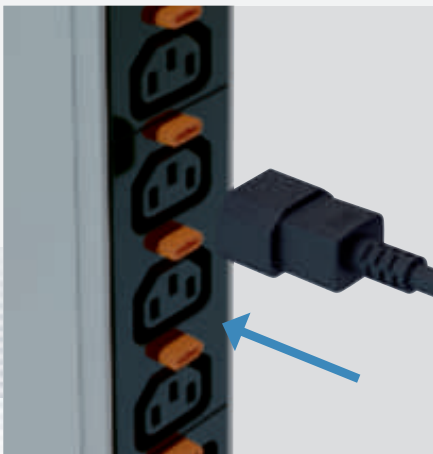

**CORD CONNECTION**  
The cord is connected to the outlet naturally in one smooth action

**2 AUTO LOCKING** ✓

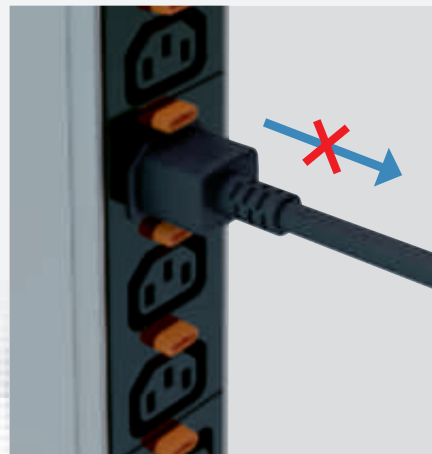

**CORD HELD IN PLACE**  
Once the power supply cord is connected, it locks automatically and cannot be removed

**3 UNLOCKING** ✓

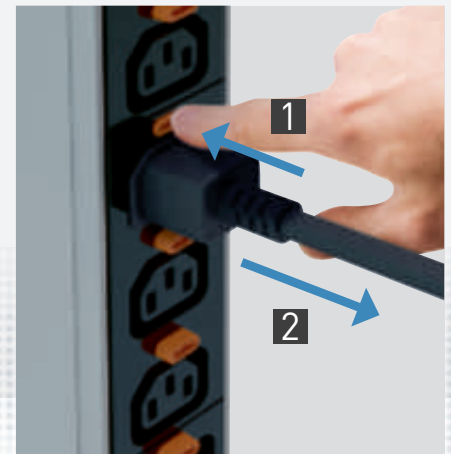

**EASY REMOVAL**  
Simply pressing the unlock button releases the cord from the outlet

**UNIVERSAL SYSTEM**

Takes all cords for standard C13 and C19 outlets



✓ **EXCLUSIVE TO LEGRAND**



# ZERO-U PDUs

## Innovation & performance

### Exclusive innovations

Every detail matters! Legrand's unique and novel innovations, which include safety features, simplified setup and integration, and consumption indicators, help ensure optimum performance for the Zero-U range of PDUs.

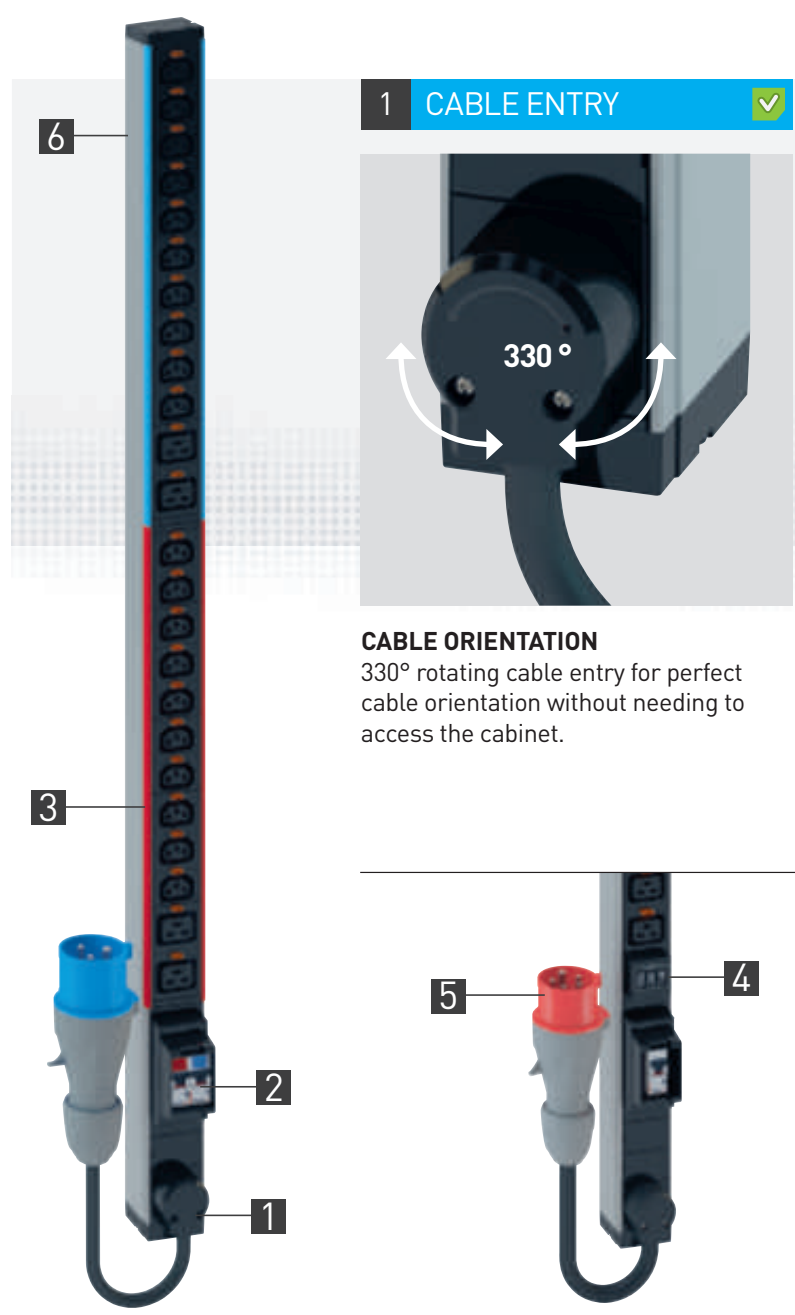

VERTICAL  
INSTALLATION



## 2 MCB HOLDER

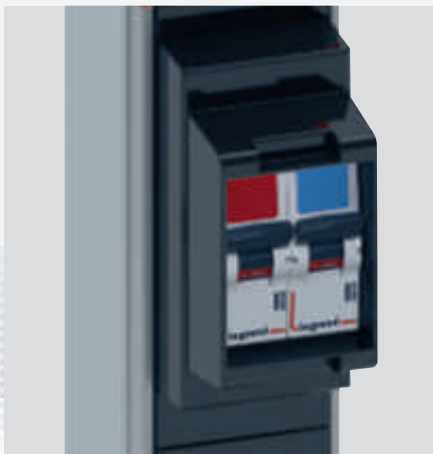

### ENHANCED PROTECTION

Circuits protected by MCB. Holder with projecting edges to avoid unintended operation (a cover can be added on request).

## 3 IDENTIFICATION

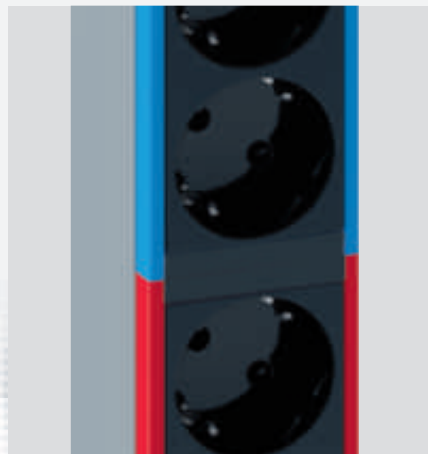

### COLOUR-CODED CIRCUITS

Each circuit is colour-coded, with the colour clearly visible on the front panel and along the edges of a module.

The colour corresponds to the specific MCB protecting the circuit.

## 4 AMMETER



### CONSUMPTION INDICATOR

Consumption is measured to ensure better installation management:

- Balancing circuits
- Display of available capacity
- Power features and overload prevention

## 5 POWER SUPPLY

There are multiple solutions depending on power supply requirements

16/32 A single-phase



16/32 A three-phase



## 6 SCREWLESS MOUNTING

Zero-U PDUs simply clip vertically into slots on the mounting frame without the need for any screws.

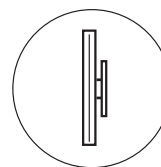

EXCLUSIVE TO LEGRAND





# 1U PDUs

## Innovation & Convenience

Simple setup and integration

The 19" PDUs designed for installation in server and cabling cabinets also incorporate the latest innovations for facilitating integration and maintenance, with clever mounting and operating features.

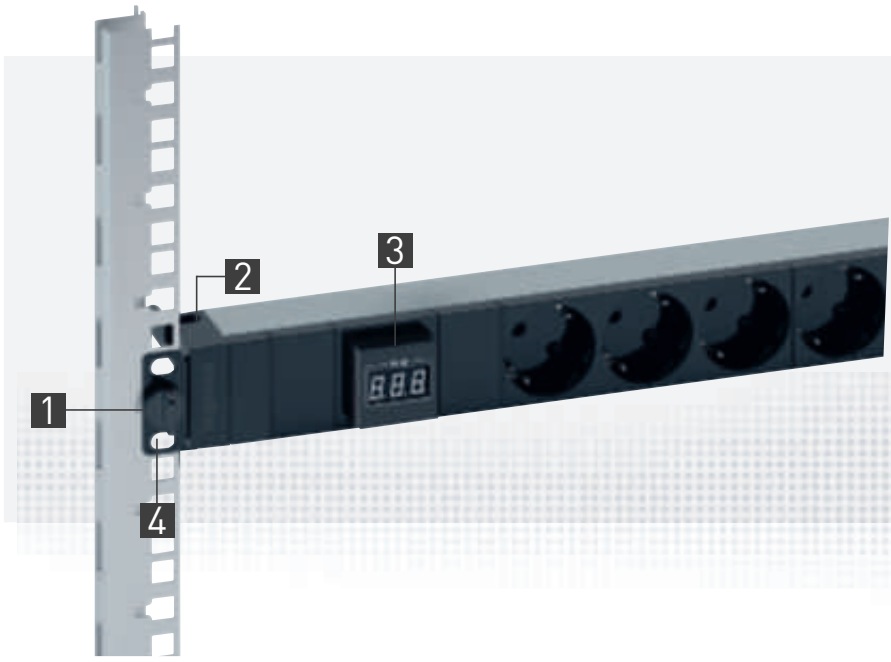

### 10" 1U PDUs

Specially designed for local area networks, these PDUs feature the same innovations as the 19" range.

HORIZONTAL INSTALLATION 



HORIZONTAL  
OR VERTICAL  
INSTALLATION



### 1 QUICK FIXING

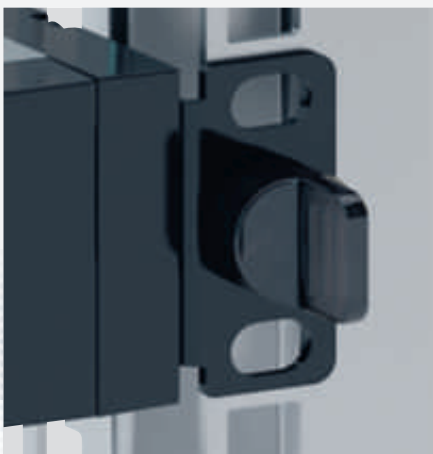

#### TOOLLESS INSTALLATION

Quick, toolless fixing on the 19" uprights. No screws or nuts required.

### 2 CABLE GUIDE



#### OPTIMISED SPACE

Cables are held firmly in place by a cable guide.

### 3 AMMETER

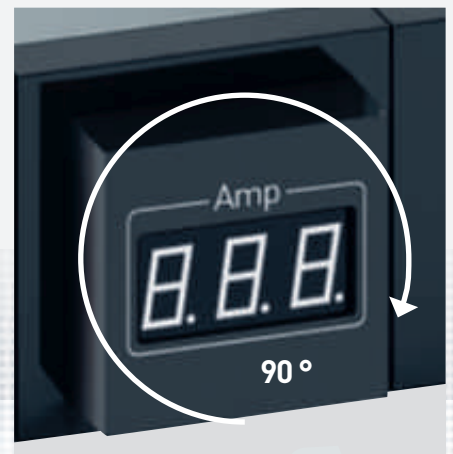

#### CHANGE OF POSITION

The ammeter can be rotated 90° to ensure easy reading regardless of mounting position (horizontal or vertical).

## 4 MOUNTING SUPPORTS

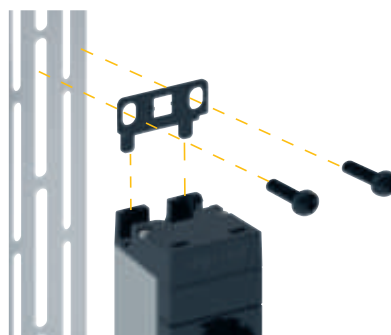
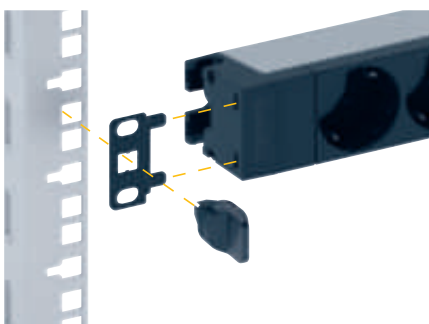

#### HORIZONTAL OR VERTICAL

Designed for horizontal toolless mounting, 1U PDUs can also be mounted vertically simply by rotating the mounting brackets. Vertical mounting requires a bolt and nut to fix the PDU firmly to the upright.

EXCLUSIVE TO LEGRAND



# Protection accessories

Enhanced safety and control

Compatible with all the PDUs in the range, the complementary accessories allow you to control the power supply at the outlets and protect against overvoltages.

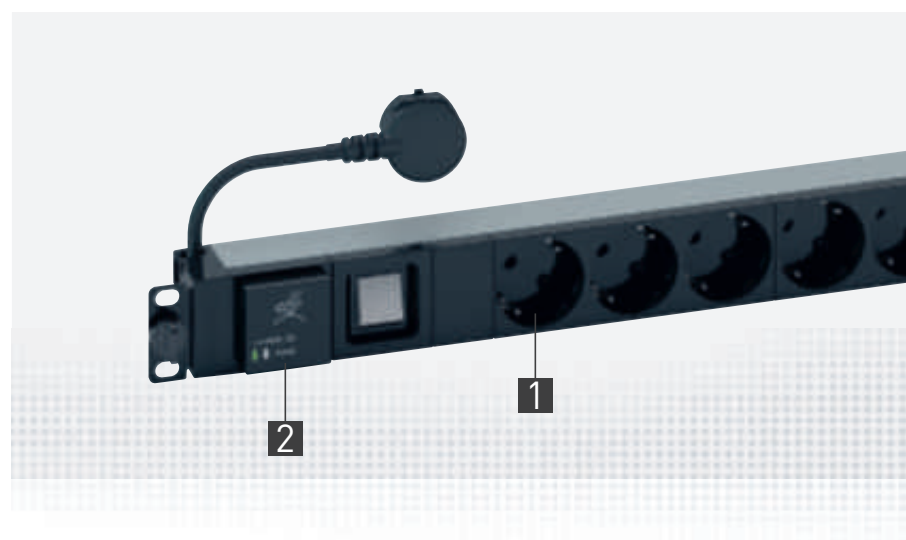



1 OUTLET LOCKING CAP ✓



**CONTROLLING ACCESS TO THE POWER SUPPLY**

Locking caps are used to lock access to a socket. A special key is required to unlock it.

Locking caps available for the following standard socket outlets:  
C13, C19, German, French-Belgian, British



2 SURGE PROTECTION DEVICE



**UNINTERRUPTIBLE PROTECTION**

The surge protection module protects equipment against overvoltages and incorporates hot swap technology. It can be used to replace a used module without interrupting the power supply to the other equipment connected to the PDU.

This is an essential accessory for business servers which need continuous protection. The module is equipped with a warning LED which indicates when it needs replacing.

✓ EXCLUSIVE TO LEGRAND

# Support you can rely on

It takes more than just sophisticated technological solutions to manage international projects successfully. What is really needed is the comprehensive and expert support of an experienced partner: from project design and choice of the right solution through to on-site logistics, installation and configuration, including any subsequent troubleshooting and maintenance.

Legrand is ideally placed to offer this type of support, as all its products and solutions are developed and produced in close proximity to its customers. It also offers a wide range of special services and support tools which create genuine added value by making customers' day-to-day business significantly easier. This support is available at every stage of the project, whatever the customer touchpoint.





**01** A diverse range of digital tools including websites, social media and news feeds so you can contact Legrand at any time and stay up to date with all essential news that is relevant to your projects.



**02** Personal advice, technical support and documents, white papers, catalogues and e-catalogues, mobile apps, and software to help with product choice or drawing up bills of materials.

**03** Training courses covering actual product expertise as well as the latest developments in technology, standards and regulations. Customised training courses available on request, either face to face or in virtual online classes.

**04** Configurators, project software and AutoCAD libraries for project design, open for integration into existing software solutions wherever possible.

# Evolution of standard 11801 Edition 3 - 2018

## Introduction

Within customer premises, the importance of the cabling infrastructure is similar to that of other fundamental building utilities such as heating, lighting and mains power. As with other utilities, interruptions to service can have a serious impact. Poor quality of service due to lack of design foresight, use of inappropriate components, incorrect installation, poor administration or inadequate support can threaten an organisation's effectiveness.

Historically, the cabling within premises comprised both application-specific and multipurpose networks. The original edition of this standard enabled a controlled migration to generic cabling and the reduction in the use of application-specific cabling. The subsequent growth of generic cabling designed in accordance with ISO/IEC 11801 has:

- a) contributed to the economy and growth of Information and Communications Technology (ICT)
  - b) supported the development of high data rate applications based upon a defined cabling model, and
  - c) initiated development of cabling with a performance surpassing the performance classes specified in ISO/IEC 11801:1995 and subsequent editions:
- ISO/IEC 11801:1995 (Ed. 1) - first edition
  - ISO/IEC 11801:2000 (Ed. 1.1) - Edition 1, Amendment 1
  - ISO/IEC 11801:2002 (Ed. 2) - second edition
  - ISO/IEC 11801:2008 (Ed. 2.1) - Edition 2, Amendment 1
  - ISO/IEC 11801:2010 (Ed. 2.2) - Edition 2, Amendment 2

The 3rd Edition of ISO/IEC 11801 is now a multipart standard with the structure shown below. It is at the Final Draft International Standard (FDIS) stage in 2017, and is due to be published in early 2018:

ISO/IEC 11801 3rd Edition
General requirements (11801-1)
Specific requirements for premises:
- Offices & commercial buildings (11801-2)
- Industrial premises (11801-3)
- Homes (11801-4)
- Data centers (11801-5)
- Distributed building services (11801-6)

The International Standard ISO/IEC 11801-1 will specify requirements for balanced twisted-pair copper (Classes A, B, C, D, E, EA, F, FA, I and II), and fibre optic (OM1, OM2, OM3, OM4, OM5, OS1a, and OS2) cabling systems used in offices (ISO/IEC 11801-2), industrial buildings (ISO/IEC 11801-3), homes (ISO/IEC 11801-4), data centers (ISO/IEC 11801-5), and for the distribution of services in buildings (ISO/IEC 11801-6). This standard series will specify the structure and minimum configurations of generic cabling, performance requirements of channels, links, connecting hardware and cords, implementation requirements, compliance requirements and verification procedures, and interfaces. Requirements for cable performance are made via reference to applicable IEC standards.

Dealing with balanced twisted-pair cabling, new Classes I and II are specified with Category 8.1 (RJ45 connector) and Category 8.2 (proprietary connector) components respectively.

### Balanced Twisted-Pair Class Specifications of ISO/IEC 11801-1:

- Class A is specified up to 100 kHz
- Class B is specified up to 1 MHz
- Class C is specified up to 16 MHz
- Class D is specified up to 100 MHz
- Class E is specified up to 250 MHz
- Class EA is specified up to 500 MHz
- Class F is specified up to 600 MHz
- Class FA is specified up to 1000 MHz
- Class I and Class II are specified up to 2000 MHz

Significant changes from the previous edition include: Class I and II channel and link requirements have been added

- Category 8.1 and 8.2 connecting hardware and cord requirements have been added
- Cabled OM1, OM2, and OS1 optical fibre is no longer recommended for new installations
- Cabled wideband OM4 (OM5) and OS1a optical fibre requirements have been added

This International Standard provides:

- a) users with an application-independent generic cabling system capable of supporting a wide range of applications
- b) users with a flexible cabling scheme making modifications both easy and economical
- c) building professionals (for example, architects) with guidance allowing the accommodation of cabling before specific requirements are known; that is, in the initial planning for either new construction or refurbishment
- d) industry and application standardisation bodies with a cabling system which supports current products and provides a basis for future product development.

This International Standard specifies a multi-vendor cabling system which can be implemented with material from single and multiple sources, and is related to:

- a) international standards for cabling components developed by committees of the IEC, for example copper cables and connectors as well as fibre optic cables and connectors (see Clause 2 and bibliography)
- b) standards for the installation and operation of information technology cabling as well as for the testing of installed cabling (see Clause 2 and bibliography)
- c) applications developed by technical committees of the IEC, by subcommittees of ISO/IEC JTC 1 and by study groups of IEEE 802 and ITU-T, for example for LANs and ISDN
- d) planning and installation guides which take into account the needs of specific applications for the configuration and the use of cabling systems on customer premises (for example ISO/IEC 14709 series, ISO/IEC 14763 series, ISO/IEC 30129, and ISO/IEC 18598).



Physical layer requirements for the applications listed in Annex E have been analysed to determine their compatibility with the cabling classes specified in this standard. These application requirements, together with statistics concerning the topology of premises and the model described in ISO/IEC 11801-2 clause 8.2, have been used to develop the requirements for Classes A to FA and fibre optic cabling systems.

In offices, horizontal balanced cabling should now be designed to provide minimum Class E, and minimum Class EA is recommended to support applications with data rates exceeding 1 Gigabit/sec.

### Scope of ISO/IEC 11801-1: Generic cabling for customer premises – Part.1 General requirements

This International Standard specifies requirements that are common to the other parts of the ISO/IEC 11801 series. Cabling specified by this standard supports a wide range of services including voice, data, and video that may also incorporate the supply of power.

This International Standard specifies:

- a) The fundamental structure and configuration of generic cabling requirements within the type 400 premises defined by the other standards in the ISO/IEC 11801 series
- b) channel transmission and environmental performance requirements
- c) link performance requirements
- d) component performance requirements, referring to available International Standards for 404 components and test methods where appropriate
- e) test procedures to verify compliance with the cabling transmission performance requirements 406 of the 11801 series documents.

Note: This International Standard does not contain specific compliance requirements. The cabling design documents supported by ISO/IEC 11801-1 incorporate the requirements of this standard as part of their individual compliance requirements.

In addition, ISO/IEC 11801-1 provides information regarding the applications supported by the cabling channels. ISO/IEC 11801-1 has taken into account requirements specified in the application standards listed in Annex E.

### Scope of ISO/IEC 11801-2 – Generic cabling for customer premises – Part.2 Office premises

This International Standard specifies generic cabling for use within office premises, which may comprise single or multiple buildings on a campus. It covers balanced cabling and fibre optic cabling.

ISO/IEC 11801-2 is optimised for premises where the maximum distance over which telecommunications services can be distributed is 2000 m. The principles of this International Standard may be applied to larger installations.

Cabling specified by this standard supports a wide range of services including voice, data, and video that may also

incorporate the supply of power.

This International Standard specifies directly or via reference to ISO/IEC 11801-1:

- a) the structure and minimum configuration for generic cabling within office premises
- b) the interfaces at the telecommunications outlet (TO)
- c) the performance requirements for cabling links and channels
- d) the implementation requirements and options
- e) the performance requirements for cabling components
- f) the compliance requirements and verification procedures.

ISO/IEC 11801-2 has taken account of the requirements specified in application standards listed in ISO/IEC 11801-1:201X, Annex E.

Safety (e.g. electrical safety and protection and fire) and Electromagnetic Compatibility (EMC) requirements are outside the scope of this International Standard, and are covered by other standards and by regulations. However, information given by this standard may be of assistance.

Scope of ISO/IEC 11801-6 – Generic cabling for customer premises – Part. 6 Distributed building services.

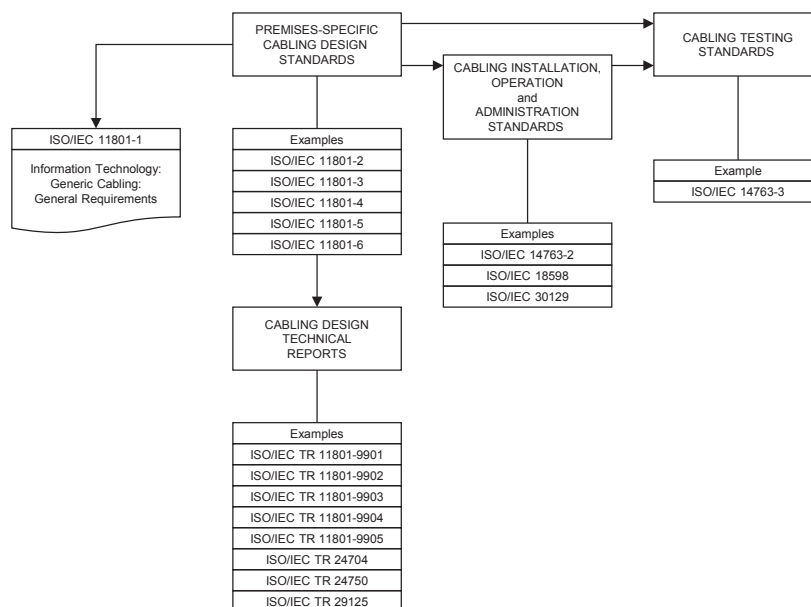

The information in this Figure is not automatically updated following the introduction, or removal, of international standards or Technical Reports

Source: ISO/IEC 11801-1 [2017]

The figure shows the schematic and contextual relationships between the standards relating to information technology cabling produced by ISO/IEC JTC 1/SC 25, namely the ISO/IEC 11801 series of standards for generic cabling design, standards for the installation, operation and administration of generic cabling and for testing of installed generic cabling.

The life expectancy of generic cabling systems can vary depending on environmental conditions, supporting applications, ageing of materials used in cables, and other factors, such as access to pathways (campus pathways are more difficult to access than building pathways). With appropriate choice of components, generic cabling systems meeting the requirements of this International Standard are expected to have a life expectancy of at least ten years.

# CAT. 8 - Understanding the new performance category for balanced twisted pair cables

## Introduction

Ethernet is now widely deployed as a preferred networking solution for many types of application ranging from small businesses to large enterprises. Increased network traffic, driven by server virtualization and converged networking, is driving the need for higher bandwidth server connections.

Ethernet BASE-T interfaces, using balanced twisted pair cabling, are prevalent. They are ideal for network environments with a mixed set of applications, equipment and networking port speeds. The ability to auto-negotiate between application speeds allows easy migration to higher operating speeds on an as-needed basis, while maintaining compatibility with existing equipment. This, along with its cost-effectiveness, makes balanced twisted pair cabling still a very popular medium for supporting Ethernet applications.

Category 6A performance was defined to support 10 Gigabit Ethernet (GbE) over balanced twisted pair cabling in a channel, up to 100 m. This standard was ratified in February 2008.

In 2010, the Institute of Electrical and Electronics Engineers (IEEE) ratified the 802.3ab standard defining 40 Gbps and 100 Gbps Ethernet transmission. There are many options for the physical medium dependent (PMD) sublayer that defines the transmission and reception details of the physical layer. The majority of the options are listed below. As you can see, most PMDs listed are for 40/100 Gbps transmission over fibre. There is a shielded copper cable option for both 40 and 100 GbE for up to 7 m, but the supported medium is twinax cable. There is no option for balanced twisted pair cable.

## What initiated the development of Category 8?

The IEEE 802.3 NGBASE-T Call-for-Interest (CFI) led to the formation of a Study Group to investigate and possibly develop this technology. In March, 2013, IEEE approved the formation of the task group IEEE 802.3bq to develop the 40GBASE-T Ethernet Standard for supporting 40 GbE over cost-effective twisted pair cabling.

**Some of the main objectives of the 802.3bq group are the following:**

- Support full duplex operation only
- Preserve the 802.3 Ethernet frame format utilizing the 802.3 MAC
- Preserve the minimum and maximum frame size of the current 802.3 standard
- Support a Bit Error Rate (BER) better than or equal to 10<sup>-12</sup>
- Support auto-negotiation
- Support energy-efficient Ethernet
- Support local area networks using point-to-point links over structured cabling topologies, including directly connected link segments
- Do not preclude meeting FCC and CISPR EMC requirements
- Support a data rate of 40 Gbps
- Define a link segment based upon copper media specified by ISO/IEC JTC1/SC25/WG3 and TIA TR-42.7 meeting the following characteristics:
  - 4-pair, balanced twisted pair copper cabling
  - Up to two connectors
  - Up to at least 30 m
- Work in TIA 42.7 was initiated in 2013 to support this new PMD for 40GBASE-T.

## Summary of Physical Layer Options for Supporting 40 and 100 GbE

PMD/INTERFACE	IEEE STANDARD	SUPPORTED MEDIA
40GBASE-SR4	802.3ab	OM3 multimode fibre (d 850 nm (4-channel) up to 100 m OM4 multimode fibre (d 850 nm (4-channel) up to 150 m
40GBASE-LR4	802.3ab	Singlemode fibre (d1310 nm (CWDM) up to 10 km
40GBASE-CR4	802.3ab	Twinax cable (4-channel) up to at least 7 m
40GBASE-KR4	802.3ab	Backplane (4-channel) up to 1 m
100GBASE-SR10	802.3ab	OM3 multimode fibre (d 850 nm (10-channel) up to 100 m OM4 multimode fibre (d 850 nm (10-channel) up to 150 m
100GBASE-LR4	802.3ab	Singlemode fibre (d 1310 nm (CWDM) up to 10 km
100GBASE-ER4	802.3ab	Singlemode fibre (d 1310 nm (CWDM) up to 40 km
100GBASE-CR10	802.3ab	Twinax cable (10-channel) up to at least 7 m

IEEE announced a Call-for-Interest (CFI) for a new application, NGBASE-T in July 2012. NGBASE-T stands for Next Generation BASE-T beyond 10 Gbps. "BASE-T" signifies that the medium will be balanced twisted pair cabling

## TIA Category 8 specification

The TIA 42.7 Working Group completed the Category 8 performance specification standard in June, 2016. The Category 8 channel is a 2-connector model using foiled twisted pair (FTP) cable with a maximum permanent link length of 24 m, as shown in Figure 1 below. Category 8 transmission performance is specified from 1 MHz to 2000 MHz.

### Category 8 Channel



The horizontal backbone cable will consist of four balanced twisted pairs with conductors ranging from 22 AWG to 24 AWG. The cord cable consists of four balanced twisted pairs with conductors ranging from 22 AWG to 26 AWG. Category 8 is a shielded solution with no specifications for bundled or hybrid cables. Category 8 uses the RJ45, an eight-position modular jack common to BASE-T applications, supported over structured cabling systems, defined within TIA. It will also support auto-negotiation for backwards compatibility since it still uses the 4-pair balanced twisted pair cable used by other cable categories.

The length of the channel can vary from 28 m to 32 m, depending on the length of cords (patch/equipment cords) allowed. This is because the patch cord length allowed depends on a derating factor. The derating factor is based on the wire gauge size (AWG) of the conductor used in the cordage. See Table 2 for the length of cordage allowed based on the de-rating factor.

#### Patch Cord Derating Factor Based on a 24-Metre Permanent Link

EQUIPMENT CORD DERATING FACTOR	CORD LENGTH ALLOWED (M)
0% (22/23 AWG)	8
20% (24 AWG)	6
50% (26 AWG)	4

Although this is a great departure from the traditional 100 m, 4-connector channel, Category 8 has to be backwards-compatible with existing cabling and equipment to allow auto-negotiation between 100 Mbps, 1 Gbps, 10 Gbps and 40 Gbps over balanced twisted pair cabling. The Category 8 specification is Addendum 1 of the TIA-568-C.2 standard (ANSI/TIA-568-C.2-1).

## Currently, ISO has the following category and class specifications:

- **Category 5** components provide Class D balanced cabling performance (specified to 100 MHz)
- **Category 6** components provide Class E balanced cabling performance (specified to 250 MHz)
- **Category 6A** components provide Class EA balanced cabling performance (specified to 500 MHz)
- **Category 7** (shielded) components provide Class F balanced cabling performance (specified to 600 MHz)
- **Category 7A** (shielded) components provide Class FA balanced cabling performance (specified to 1000 MHz)

TIA performance specifications do not recognise Category 7 or 7A (shielded solutions). ISO has also been working on Category 8.1 and 8.2 component specifications to support a new Class I and II channel specification respectively. The existence of these ISO performance specifications is the reason TIA chose Category 8 as the next performance specification.

The Class I specification is similar to the current TIA Category 8 specification. Originally, the ISO Class I channel and 8.1 component performance was specified only to 1.6 GHz. ISO has extended the performance specification to 2 GHz, and like the TIA has not initiated any work similar to ISO's Class II and Category 8.2 specifications which extend performance and use connectors other than RJ45.





## ISO/IEC Category 8 specification

ISO is the International Organization for Standardization. It creates standards for structured cabling similar to TIA, with participation from international organisations; the US also has a participating delegation. The ISO/IEC 11801 standard is similar to the ANSI/TIA-568 standard.

Both organisations are trying to harmonise the standards but there are some differences. For example, ISO specifies the channel performance specification as a “Class” and component performance specifications as a “Category”. TIA has traditionally used “Category” to refer to the component, link and channel performance specifications.

ISO recognises several connector types for Category 8. These interfaces are shown in Table 3 below. Category 8.1/Class I uses an RJ45 interface. This is the same interface used in all TIA category specifications (TIA-568-C.2 standard), including the Category 8 specification. ISO recognizes three interfaces for Category 8.2/Class II; the TERA, GG45, and ARJ45. These are also recognised Category 7A interfaces in ISO. It remains uncertain whether TIA will adopt any of these connector interfaces if they create a Class II specification similar to ISO in the future.

### Connection Interfaces for Category 8 in ISO Standards

PMD/INTERFACE	SUPPORTED MEDIA	TYPE	DWG DESCRIPTION
Category 8.1/Class I	TIA 568-C.2 ISO/IEC 11801	RJ45	
Category 8.2/Class II	IEC 61076-3-104 [C7A Interface]	TERA <sup>1</sup>	
	IEC 60603-7-71 [C7A Interface]	GG45 <sup>2</sup>	
	IEC 61076-3-110 [C7A Interface]	ARJ45 <sup>3</sup>	

Notes: 1. TERA® is a registered trademark of The Siemon Company.  
 2. GG45® is a registered trademark of Nexans (France).  
 3. ARJ45® is a registered trademark of Bel Fuse Ltd (Hong Kong).

## What is the application

Development of a Category 8 performance standard was driven by the need to support the next generation of NGBASE-T. The need for the next generation BASE-T standard was substantiated by a need to support Ethernet beyond 10GbE for server-to-switch connections. The existing 40 GbE over copper standard (ratified in 2010), 40GBASE-CR4, defines 40 Gbs over twinax cable for up to 7 m. This is sufficient for use within a rack or a neighbouring rack but not sufficient for supporting other architectures within a data center. Therefore, the initial application driving the development of NGBASE-T and Category 8 was support for server-to-switch connections within a row, such as end-of-row or middle-of-row architectures.

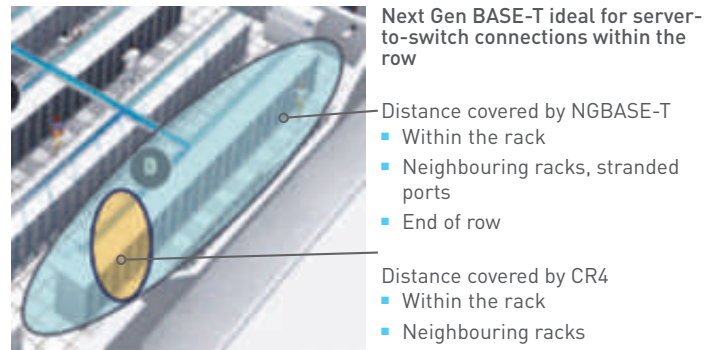

Category 8 will allow support of 40 Gbps over balanced twisted pair cable for 28 to 32 m depending on the patch cord wire gauge (AWG) used. This distance works well for use within racks, neighbouring racks, and end-of-row racks. Switch fabrics, such as leaf and spine, are growing in popularity in the data center and may also provide an application for Category 8. Category 8 will use an RJ45 interface, which is backwards-compatible with previous TIA category standards and will support auto-negotiation, making transitions to faster data applications easy.

A document has also been produced in TIA that identifies opportunities for high-performance structured cabling (i.e. Category 8). The TIA TR-42.7 subcommittee approved a new Technical Service Bulletin, TIA TSB-5019, “High Performance Structured Cabling Use Cases for Data Centers and Other Premises” published at the April 2015 plenary meeting. This document is intended to provide details for deploying future Category 8 structured cabling in data centers and other premises to support 25GBASE-T and 40GBASE-T applications. The document identifies, analyses and recommends architectures such as switch fabric, end-of-row, middle-of-row and top-of-rack for high-performance structured cabling using next generation BASE-T standards with data rates above 10GBASE-T such as 25GBASE-T and 40GBASE-T. These examples can be used in data center or premise designs such as test labs or equipment rooms requiring high bandwidth solutions.



## What are the challenges?

One of the biggest challenges has been defining the measurement technology required to assess and verify Category 8 component, link and channel performance. The frequency range has drastically increased from 500 MHz for Cat. 6A to 2000 MHz for Cat. 8. There are several task groups working on this.

Addendum 1 to the ANSI/TIA-1183: Measurement Methods and Test Fixtures for BalunLess Measurements of Balanced Components and Systems standard was completed in January 2016. This standard is intended to be used as an independent testing reference and describes methods and fixtures that support laboratory measurement of all differential mode, mixed mode, and common mode transmission parameters up to 1 GHz. Category 8 requires the frequency range to be extended to 2 GHz.

ANSI/TIA-1152-A, the requirements for field-testing balanced twisted pair cabling, including Category 8 performance, was approved for publication at the October plenary meeting.

This standard provides requirements for field test instruments, as well as measurement methods for comparing field instrument measurements against measurements obtained using laboratory equipment. The challenge was that the frequency range to be tested had to be increased from 500 MHz (Cat. 6A) to 2000 MHz for Cat. 8.

The table lists the field tester accuracy levels. TIA published the Category 8 standard in July 2016 and ISO should be published in the first quarter of **2017 IEC 61935-1**.

### Field Tester Accuracy Levels

CABLING STANDARD	FREQUENCY RANGE (MHz)	ACCURACY LEVEL
CAT 5e	100	Level II
CAT 6	250	Level III
CAT 6A	500	Level IIIe
CAT 8	2000	Level 2G

### ISO by IEC (and IEC 61935-1)

CABLING STANDARD	FREQUENCY RANGE (MHz)	ACCURACY LEVEL
CLASS F	600	Level IV
CLASS FA	1000	Level V (draft)

## Summary and conclusions

Will Category 8 be widely adopted? That is the question being asked by many. A twisted-pair Ethernet (BASE-T) solution has advantages such as being one of the most widely adopted structured cabling technologies, low cost, using a common connector interface and auto-negotiation capabilities. The Category 8 standard does specify the RJ45 interface, making it compatible with all other TIA balanced twisted pair cabling standards.

The Category 8 channel length has been reduced from the historical 100-metre channel length and is a shielded solution, with the channel being limited to 2 connectors. Both the 30-metre channel length (can vary from 28-32 m depending on the cords) and 2-connector channel limitations must be included in designs intended to support future BASE-T applications.

How widely will Category 8 be adopted? Will fibre be less expensive? Time will tell, however, you should keep an eye on the active equipment manufacturers because they have a huge influence on what gets adopted.

TIA published the Category 8 standard in July 2016 and ISO should be published in the first quarter of 2018.

# Fibre optic system - Transmission speed from 40 Gbps to 100 Gbps

## IEEE and TIA ISO/IEC standards

IEEE 802.3 is a working group within the Institute of Electrical and Electronics Engineers (IEEE) professional organisation. It is also a collection of IEEE standards produced by the working group defining the physical layer and the media access control layer (MAC) of wired Ethernet. (There are other groups responsible for wireless, etc.) These standards define technology, generally specific to local area networks, with some wide area network applications. The standards define the physical connections between nodes and/or infrastructure devices like hubs, switches, routers, etc. and various types of copper or fibre optic cable.

The Telecommunications Industry Association (TIA) and the SC25 committee in ISO/IEC defines the performance for structured cabling at the component level, link level and channel level to support an application over the distance specified. Sometimes a new performance category needs to be defined to support a new application.

The purpose of standards is to provide the minimum requirements to guarantee applications will function properly with equipment from any manufacturer. Using TIA or ISO/IEC structured cabling assures interoperability between components from different manufacturers.

## 40/100 Gbps transmission

In 2010, the IEEE 802.3ba standard defining 40 Gbps and 100 Gbps Ethernet transmission primarily over optical fibre was ratified. This was based on the IEEE 802.3ae standard defining 10 GbE transmission ratified in 2002, which made development of the standard much easier and faster. IEEE did not develop a completely new transmission definition for 40G bps and 100 Gbps transmission over two fibres like 10 GbE. Both 40 GbE and 100 GbE were based on using parallel transmission paths transmitting 10 Gbps; 40 GbE requires four channels and 100 GbE requires ten channels for both transmission and reception. This was a departure from previous fibre optic systems.

In 2015, IEEE released a new standard, 802.3bm, which provides a new version of 100 GbE to reduce costs. This standard reduces the number of transmission channels from 10 to 4 by increasing the modulation rate from 10 Gbps to 25 Gbps in each channel. This will make it very easy to update the infrastructure from 40 GbE to 100 GbE because both use the same number of fibres for transmission.

Every application that IEEE802.3 defines has a Physical Medium Dependent (PMD) sublayer as part of the specification. The PMD sublayer defines details of transmission and reception of individual bits on a physical medium. Table 1 lists most of IEEE's 40 Gbps Ethernet PMDs, including the PMD name, type of medium and distance over which application is supported. PMD names are often used when naming transceivers.

**Table 1: IEEE Objectives for 40-Gigabit Ethernet**

Objective	Resulting PMD	Description of PMD
100m on OM3 <sup>1</sup> MMF <sup>2</sup> (850nm)	40GBASE-SR4	40 Gbps PHY using 40GBASE-R encoding over (4) lanes of multimode fiber with a reach up to at least 100m (can support at least 150m over OM4 MMF <sup>2</sup> )
150m on OM4 <sup>3</sup> MMF <sup>2</sup> (850nm)		
10km on SMF <sup>4</sup> (1310nm)	40GBASE-LR4	40 Gbps PHY using 40GBASE-R encoding over (4) wavelength division multiplexing (WDM) lanes of single-mode fiber with a reach up to at least 10km
40km on SMF <sup>4</sup> (1310nm)	40GBASE-ER4	40 Gbps PHY using 40GBASE-R encoding over (4) wavelength division multiplexing (WDM) lanes of single-mode fiber with a reach up to at least 40km
7m over copper	40GBASE-CR4	40 Gbps PHY using 40GBASE-R encoding over (4) lanes of shielded balanced copper cabling <sup>5</sup> with a reach up to at least 7m
1m over backplane	40GBASE-KR4	40 Gbps PHY using 40GBASE-R encoding over (4) lanes of an electrical backplane with a reach up to at least 1m

- OM3 is a 50 micron, laser-optimized multimode fiber
- MMF stands for multimode fiber
- OM4 is a 50 micron, laser-optimized multimode fiber with higher bandwidth than OM3
- SMF stands for singlemode fiber
- Twinax cabling is used

The initial goals were to support 40GbE for at least 100 m over multimode fibre, up to at least 10 km over singlemode and up to 7 m over shielded balanced copper (Twinax). With the release of OM4 (a 50-micron laser-optimised multimode fibre (LOMF) with higher bandwidth than OM3) the distance can be extended to 150 m. Another PMD was added in 2015 to support 40 GbE over singlemode up to at least 40 km. There is also a PMD defined for supporting 40 GbE for at least 1 m over an electrical backplane.

Table 2 lists the objectives for supporting 100 GbE over specific media.

**Table 2: IEEE Objectives for 100 Gigabit Ethernet**

Objective	Resulting PMD	Description of PMD
100m on OM3 MMF <sup>1</sup> (850nm) 150m on OM4 MMF <sup>1</sup> (850nm)	100GBASE-SR10	100 Gbps PHY using 100GBASE-R encoding over (10) lanes of multimode fiber with a reach up to at least 100m (can support at least 150m over OM4 MMF1)
70m on OM3 MMF <sup>1</sup> (850nm) 100m on OM4 MMF <sup>1</sup> (850nm)	100GBASE-SR4	100 Gbps PHY using 25 Gbps data rate over (4) lanes of multimode fiber with a reach up to at least 100m (can support at least 100m over OM4 MMF or 70m over OM3 MMF)
10km on SMF <sup>2</sup> (1310nm)	100GBASE-LR4	100 Gbps PHY using 100GBASE-R encoding over (4) wavelength division multiplexing (WDM) lanes on single-mode fiber with a reach up to at least 10km
40km on SMF <sup>2</sup> (1310nm)	100GBASE-ER4	100 Gbps PHY using 100GBASE-R encoding over (4) wavelength division multiplexing (WDM) lanes on single-mode fiber with a reach up to at least 40km
7m over copper	100GBASE-CR10	100 Gbps PHY using 100GBASE-R encoding over (10) lanes of shielded balanced copper cabling <sup>3</sup> with a reach up to at least 7m

1. MMF stands for multimode fiber
2. SMF stands for single-mode fiber
3. Twinax cabling is used

The objectives for both 40 and 100 GbE are the same; supporting the application over multimode fibre for at least 100 m, over singlemode fibre for at least 10 km and a longer option of 40 km, and over balanced copper cabling (Twinax) for up to at least 7 m. One thing to keep in mind is that 100GBASE-SR4 is supported for at least 100 m over multimode fibre when using OM4 but only 70 m over OM3.

The PMDs are summarised in table 3 for 40 GbE and table 4 for 100 GbE. The tables summarise the signalling, media and distance for both 40-Gigabit Ethernet and 100-Gigabit Ethernet.

**Table 3: Signalling, Medium and Distance for 40-Gigabit Ethernet PMDs**

40 Gigabit Ethernet				
PMD Name	40GBASE-SR4	40GBASE-LR4	40GBASE-ER4	40GBASE-CR4
Signaling	4 x 10 Gbps	4 x 10 Gbps	4 x 10 Gbps	4 x 10 Gbps
Media	Parallel MMF	Duplex SMF	Duplex SMF	Twinax
Distance	0,5 – 100m OM3 / 150m OM4	10km SMF	40km SMF	7m Twinax

**Table 4: Signalling, Media and Distance for 100-Gigabit Ethernet PMDs**

100 Gigabit Ethernet					
PMD	100GBASE-SR4	100GBASE-SR10	100GBASE-LR4	100GBASE-ER4	100GBASE-CR10
Signaling	4 x 25 Gbps	10 x 10 Gbps	4 x 25 Gbps	4 x 25 Gbps	10 x 10 Gbps
Media	Parallel MMF	Parallel MMF	Duplex SMF	Duplex SMF	Twinax
Distance	100m OM4 / 70m OM3	100m OM3 / 150m OM4	10km SMF	40km SMF	7m Twinax

Some key takeaways are that both 40 GbE and 100 GbE require more than two fibres for transmission over multimode fibre. 40 GbE requires four transmit and four receive multimode fibres, making a total of eight fibres per channel.

The newer 100 GbE PMD, 100GBASE-SR4, uses the same cable plant (eight fibres) as 40 GbE, providing a seamless migration path. The singlemode options for 40 GbE and 100 GbE also require multichannel transmission. 40-Gigabit Ethernet over singlemode uses four transmit channels and four receive channels, each transmitting at 10 Gbps. 100-Gigabit Ethernet over singlemode uses four transmit and four receive channels, each transmitting at 25 Gbps. IEEE 802.3ba, the 40 Gbps and 100 Gbps Ethernet transmission standard, specifies signalling over singlemode fibre using wavelength division multiplexing (WDM) transmission. This means that for 40 GbE and 100 GbE over singlemode fibre, each of the four channels is transmitted at a different wavelength.

40GBASE-LR4 transmission is defined by a center wavelength and wavelength range for each channel. The center wavelengths used for the four channel are members of the CWDM (Conventional/Course Wavelength Division Multiplexing) grid defined in the ITU-T G.694.2 standard. This standard defines a channel spacing grid using wavelengths from 1271 to 1611 nm, with channel spacing of 20 nm. Table 5 shows the center wavelength and wavelength range for each 40GBASE-LR4 transmission channel.

## 40/100-Gigabit Ethernet connectivity and cable

100GBASE-LR4 and 100GBASE-ER4 also define a wavelength range for each channel. The wavelength range is the same for both 100GBASE PMDs as shown in table 5. These ranges are based on center frequencies that are part of the frequency grid defined in the ITU-T G.694.1 standard. This standard defines a set of frequencies used to designate allowed central frequencies to support dense wavelength division multiplexing (DWDM) applications. This standard supports a variety of channel spacing ranging from 12.5 GHz to 100 GHz and wider, beginning at 193.1 THz. 100GBASE-LR4 and 100GBASE-ER4 channels use center frequencies from 229 THz to 231.4 THz and are spaced at 800 GHz.

Table 5 shows the center frequency, correlating center wavelength and wavelength range for each 100GBASE-LR4 and 100GBASE-ER4 channel.

**Table 5: Wavelength-Division-Multiplexed Lane Assignments**

Lane	40GBASE-LR4		100GBASE-LR4 and 100GBASE-ER4		
	Center Wavelength	Wavelength Range	Center Frequency	Center Wavelength	Wavelength Range
L <sub>0</sub>	1271 nm	1264.5 to 1277.5 nm	231.4 THz	1295.56 nm	1294.53 to 1296.59 nm
L <sub>1</sub>	1291 nm	1284.5 to 1297.5 nm	230.6 THz	1300.05 nm	1299.02 to 1301.09 nm
L <sub>2</sub>	1311 nm	1304.5 to 1317.5 nm	229.8 THz	1304.58 nm	1303.54 to 1305.63 nm
L <sub>3</sub>	1331 nm	1324.5 to 1337.5 nm	229 THz	1309.14 nm	1308.09 to 1310.19 nm

Since the different wavelengths do not interfere with each other when transmitted on a single fibre, all four can be transmitted over one fibre. If all four signal channels are transmitted at the same wavelength then four fibres are needed to separate the channels as in parallel transmission over multimode. The four receive channels also use WDM transmission so 40 GbE and 100 GbE channels over singlemode only require a total of two fibres; one transmit fibre and one receive fibre. These cables typically use LC connectors. There is no requirement to associate a particular electrical channel with a particular optical channel since the transceiver is capable of receiving channels in any order.

Both 40 GbE and 100 GbE have a copper option for up to 7 m using Twinaxial cable. 802.3ba does not define a twisted pair option.

Notes: MTP® is a registered trademark of US Conec, Ltd.

Based on the aforementioned standards, all 40/100-Gigabit Ethernet options over multimode fibre use parallel transmission, requiring more than two fibres per channel. Fibre connectivity must be able to terminate more than two fibres. This is a departure from connectivity used in systems supporting up to 10-Gigabit Ethernet, which only requires a total of two fibres per channel. The most common connector for transmission over two fibres is the LC. This is the only connector recommended for new installations requiring two fibres for transmission in the TIA data center standard, ANSI/TIA-942 and ISO/IEC 11801 3rd Edition and especially ISO/IEC 11801-5 for data centers. This connector is used for 10 GbE and below over multimode fibre, as well as the 40/100 GbE singlemode options reviewed previously.

With the need to support multiple transmission channels, the Media Dependent Interface (MDI) identified by the IEEE 802.3ba standard for 40 GbE and 100 GbE transmission (when not using WDM) is the MPO-style connector. The MPO connector is the connector recommended by the ANSI/TIA-942 data center standard ISO/IEC 11801 3rd Edition and especially ISO/IEC 11801-5 for data centers for applications requiring parallel fibre transmission. The terms “MPO” and “MTP®” are used interchangeably for this style of connector. MPO is the generic name for this Multi-Fibre Push On connector style. MTP is an MPO-style connector and a registered trademark of US Conec, Ltd. It is considered in the industry to be a better performing connector with lower insertion loss.

### MPO Connector

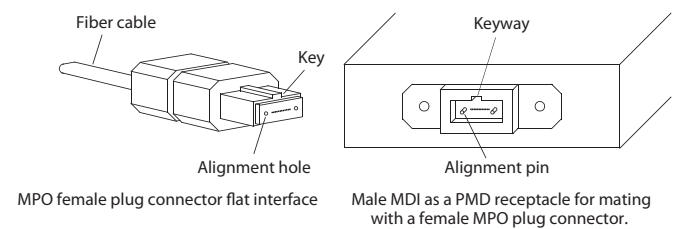



MPO connectors are typically terminated onto 12 fibres. MPOs may also be terminated onto 24 fibres. There is a keyway for maintaining polarity. (Polarity is covered in more depth later in this paper in the section entitled, "Fibre Considerations when Migrating to 40/100-Gigabit Ethernet"). The connector has precision alignment pins or holes to ensure all fibres align properly with the mating connector. The component type (i.e. cassette, adaptor panel, trunk cable) usually dictates whether there are pins or holes; pins are usually on fixed components like cassettes. If not properly cleaned, alignment pins can collect debris around the pins, resulting in the two components not mating correctly.

IEEE 802.3ba identifies specific positions on an MPO connector to use for transmission and reception. The four transmit and four receive fibre optic channels of 40GBASE-SR4 (40 GbE over multimode) must occupy the positions shown in the figure below.

Looking at the end of the MPO, with the connector key on top, the transmit fibre optic channels occupy the four leftmost positions and the receive fibre optic channels occupy the four rightmost positions. There are eight active channels within twelve positions in total, with the four middle positions unused.

#### 40G-BASE-SR4 Fibre Optic Channel Assignments

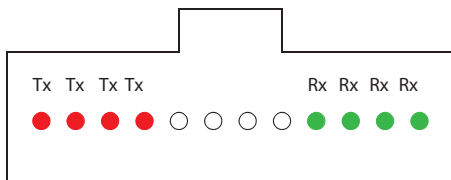

The 100GBASE-SR10 (100 GbE over multimode) requires a total of 20 fibres, 10 transmit and 10 receive. Position assignments are shown below. There are three options, the first being a single receptacle shown as Option A in figure below. Option A is recommended by IEEE. The two-receptacle options: Option B and Option C are alternatives.

Option A uses a 24-position MPO connector with the top middle 10 positions allocated for reception and the bottom 10 middle positions allocated for transmission, as shown in the figure below.

#### 100G-BASE-SR10 Fibre Optic Channel Assignments Option A: Single connector (recommended)

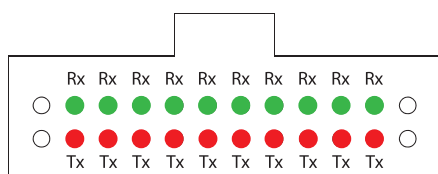

Option B and C use two 12-position MPO connectors. Option B, shown in the figure below, uses side-by-side interfaces. The 10 middle positions of the right-hand interface are used for reception and the 10 middle positions of the left-hand interface are used for transmission.

#### 100G-BASE-SR10 Fibre Optic Channel Assignments Option B: Side by side (alternative)

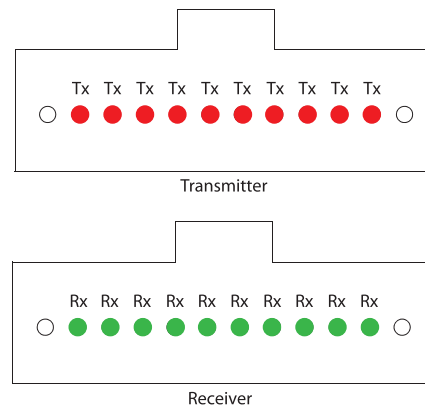

Options C is similar to option B, but uses the stacked layout depicted in the figure below. The ten middle positions of the top connector are used for reception and ten middle positions of the bottom connector are used for transmission.

#### 100G-BASE-SR10 Fibre Optic Channel Assignments Option B: Side by side (alternative)

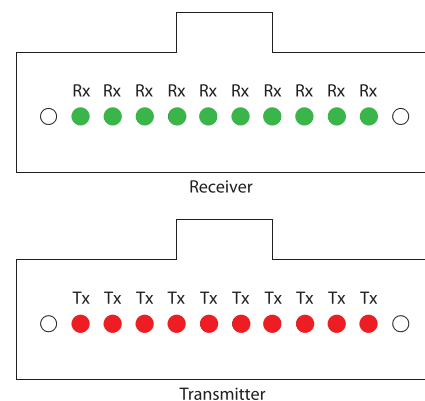

Equipment manufacturers usually play a key role in driving the adoption of a particular MDI (Media Dependent Interface) option. For example, Option A, the single 24-position MPO has more connections in a smaller footprint, making it more complex and therefore more costly to manufacture. Option B, two 12-fibre side-by-side MPO connectors, requires twice the width of the other two options. Option C, two stacked 12-position MPO connectors, is single-width, but takes up more vertical space, where rack units could potentially be added

# Fibre considerations when migrating to 40/100-Gigabit Ethernet

Multimode fibre systems have been the most cost-effective fibre solution to use in the data center because the transceivers are much less expensive than singlemode transceivers. Multimode transceivers use a vertical cavity surface emitting laser (VCSEL) light source, which is easy to manufacture and package. Multimode fibre systems have a shorter reach than singlemode systems, however most distances are less than 150 m; surveys have shown that more than 80% of data centers extend to 100 m or less. Although singlemode cable is less expensive, after factoring in the total system cost of multimode versus singlemode, multimode is still much less expensive.

Some common approaches used in data centers are summarised in Table 6 below. Each approach uses short-wavelength (850 nm) transmission over multimode fibre.

The fibre system should be designed around OM3 or OM4 MMF if there are plans to support applications beyond 10 Gbps. OM3 supports 10 GbE up to 300 m, but only supports 40 GbE up to 100 m. OM4 supports the 100GBASE-SR10 PMD up to 100 m

but only supports 100GBASE-SR4 up to 70 m so that is another important consideration. OM4 supports 10 GbE up to 550 m, but only supports 40 GbE up to 150 meters. OM4 supports the 100GBASE-SR10 PMD up to 150 m but only supports 100GBASE-SR4 up to 100 m.

If planning to support 40 GbE and/or 100 GbE in the future, the channel cannot be designed for the maximum distances over which 10G can be supported. If the data center has distances exceeding 70 m it is a good idea to use OM4, since OM4 supports 10 GbE through 100 GbE for up to at least 100 m. Always design for the application that has the most stringent requirements (usually the fastest data rates) even if the application is a future installation.

In addition to selecting the type of fibre, OM3 or OM4, there are several other important considerations when selecting components for a fibre optic cabling system. These include channel insertion loss, polarity and alignment pins.

**Table 6: Common Data Center Approaches Using Short Wavelength Transmission**

	10G	40G	100G [-SR10]	100G [-SR4]
Signalling	10Gb	10Gb x 4	10Gb x 10	25 Gb x 4
Laser Type	VCSEL	VCSEL Array	VCSEL Array	VCSEL Array
Fibre Type	OM3/OM4	OM3/OM4	OM3/OM4	OM3/OM4
Connector	2 LCs	12-fibre MPO	{2} 12-fibre MPOs or 24-fibre MPO	12-fibre MPO
Number of Fibres Needed	2 fibres 	8 fibres 	20 fibres 	8 fibres 
Maximum Distance	OM3: 300 m OM4: 550 m	OM3: 100 m OM4: 150 m <sup>1</sup>	OM3: 100 m OM4: 150 m <sup>1</sup>	OM3: 70 m OM4: 100 m

1. 150 m over OM4 requires low-loss connectors. This is discussed in the channel insertion section.

## Channel Insertion Loss/Loss Budget

The channel insertion loss is made up of the insertion loss (IL) of the cable, specified as decibels per kilometer (dB/km), the insertion loss of all mated connector pairs and the insertion loss

of splices in that channel. As can be seen in the table below, as the data rate increases from 10 Gbps to 40/100 Gbps, the total channel insertion loss or loss budget decreases noticeably.

**Table 7: Maximum Channel Insertion Loss**

	PMD Name	Fibre Type	Total Number of Fibres	Max Link Length (m)	Max Channel Insertion Loss (dBs)
10 GbE	10GBASE-SR	OM3	2	300	2.6
40 GbE	40GBASE-SR4	OM3	8	100	1.9
40 GbE	40GBASE-SR4	OM4	8	150	1.5
100 GbE	100GBASE-SR4	OM3	8	70	1.9
100 GbE	100GBASE-SR4	OM4	8	100	1.9
100 GbE	100GBASE-SR10	OM3	20	100	1.9
100 GbE	100GBASE-SR10	OM4	20	150	1.5

Understanding the impact of each component in the channel loss budget is extremely important when selecting cables and connectors. Often, the cable attenuation performance and bandwidth drive the design of the channel. The impact that a connector can have on the total channel budget can be significant.

The figure below shows the total loss budgets for a 100 m channel at different data rates common to current Ethernet applications. As data rates progress from 100 Mbps Ethernet-based systems to today's 10 Gbps Ethernet-based systems, the fibre optic loss budgets have shrunk considerably from 11 dB to 2.6 dB. 40/100 Gbps Ethernet systems have an even smaller budget of 1.9 dB when using OM3 or 1.5 dB when using OM4.

**Total Channel Insertion Loss by Application**

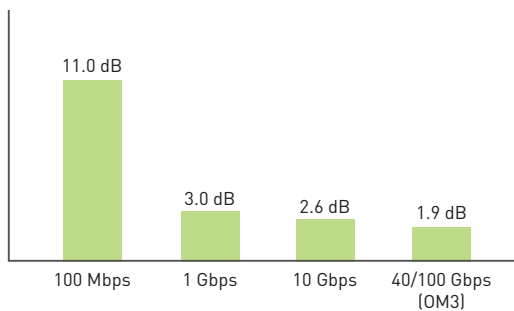

If we look at two channel insertion loss budget examples for 2 and 3 mated pairs, including the cable loss for a 100 m link at 850 nm, the importance of connector loss is apparent.

Using the standard loss for a multimode fibre cable (OM3/OM4, 850 nm) of 3 dB/km (ISO/IEC 11801 3rd Edition-Q2 2017) and an average of 0.50 dB loss per mated connector pair (TIA standards allow up to a maximum 0.75 dB loss and up to 4 connections), the calculated loss for a 100 m channel with 2 mated connector pairs is 1.35 dB ( $(3.5\text{dB/km} * 0.1\text{km}) + (0.5 * 2)$ ). Applied to the loss budgets, as shown in the figure below, this is not significant for 100 Mbps systems. However, the insertion loss takes up a little more than half of the 10G budget and almost three-quarters of the 40/100 Gbps budget.

**Channel Insertion Loss In a 100 M Channel with 2 Mated Connector Pairs**

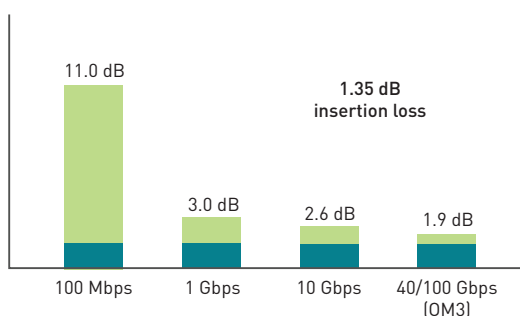

If we look at a 3-connector-pair channel, the loss budget rises to 1.85 dB ( $(3.5\text{dB/km} * 0.1\text{km}) + (0.5 * 3)$ ), as shown in the figure below. This is more than 70% of the 10 Gbps budget and almost the entire 40/100 Gbps budget. This would exceed the loss budget using OM4 for 150 m, which is 1.5 dB because of the longer distance, proving the insertion loss of a connector is very important.

**Channel Insertion Loss In a 100 M Channel with 3 Mated Connector Pairs**

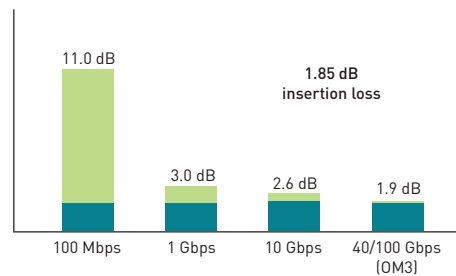

It is important to consider the trade-off. If the IL of one component can be reduced, there will be room for extra loss in another component. For example, if using OM4 at only 100 m instead of 150 m, the loss of the cable will be less because IL is directly related to distance (dB/km). This can make room for more mated connector pairs. However, all of the IL gain can easily be negated with inferior connector components.

## Polarity

Don't forget to plan for the correct polarity. Maintaining correct polarity guarantees an optical path from the transmit port of one device to the receive port of another device, known as the polarity flip. There are several different methods to maintain polarity, but the different methods may not be interoperable. There are three methods depicted in the TIA standards ISO/IEC 14763-2 "planning and installation"; methods A, B and C. There are other proprietary methods used by various manufacturers.

Each method requires a specific combination of components to maintain polarity. Assuming duplex signalling, using an MPO backbone cable, cassettes and patch cords, the following list shows the component options that are used in specific combinations for each of the polarity methods.

The options for components are:

- MPO-to-MPO backbone cables: Type A, B or C
- MPO-to-LC cassettes: Method A or Method B
- Patch cords: Type A-to-A or Type A-to-B

### A-to-A and A-to-B Patch Cords

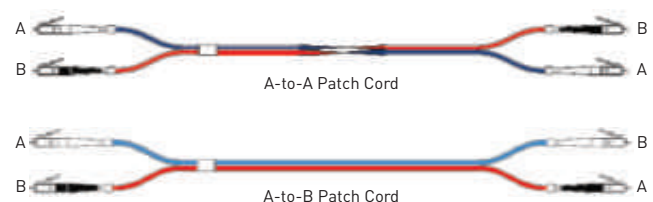

## Fibre considerations when migrating to 40/100-Gigabit Ethernet

For example, with duplex signalling, a Method A polarity scheme uses a Method A cassette, Type A trunk cable and a type A-to-B patch cord on one end of the channel and a type A-to-A patch cord on the other end. The transmit to receive flip occurs in the patch cord at one end. Method B uses a Method B cassette and trunk cable and an A-to-B patch cord at each end because the flip occurs in the cassette and trunk cable. Method C uses a Method A cassette with a Type C trunk cable and A-to-B patch cords at each end. The flip occurs in the trunk cable only.

Polarity becomes more complicated when migrating to 40/100 GbE because parallel transmission replaces duplex transmission. Parallel fibre optic links integrate multiple transmitters in one transmitter module, multiple fibres in fibre array connectors and multiple receivers in one receiver module. Multiple transmitters and receivers may also be integrated together in a transceiver module.

The three methods, A, B and C, are expanded in the ANSI/TIA-568 ISO/IEC 14763-2 standard to include links that use parallel signalling in one row (24-fibre MPO). Array connectors are keyed to maintain polarity. A keyed MPO connector is shown in the figure below.

MPO Plug Fibre Positions Looking at the Ferrule End with Key Up

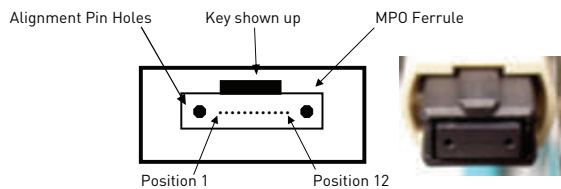

### Alignment Pins

When mating connector plugs that use alignment pins, like the MPO connector, it is critical that one plug is pinned and the other plug is unpinned. Because all known transceivers that accept MPO plugs are pinned, they accept only unpinned plugs.

MPO Connector With Pins Installed

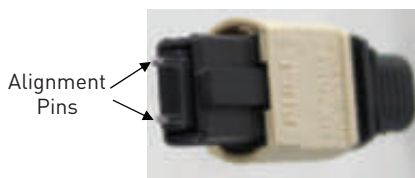

The pinned connector is typically located inside the panel to help protect the pins from being damaged (i.e. the fixed connector is pinned and the connector that is frequently removed and handled is unpinned). For example, cassettes are typically pinned and trunk cables are typically unpinned.

**Consult the manufacturer since there may be exceptions required for your design.**

**If not properly cleaned, alignment pins can collect debris around the pins, resulting in the two components not mating correctly.**

## What's coming?

IEEE has a number of ongoing projects for both copper and fibre applications. A key fibre-application project underway is for 400 GbE. The goal is to provide physical layer specifications, supporting the following link distances:

At least 100 m over MMF

At least 500 m over SMF

At least 2 km over SMF

At least 10 km over SMF

The first phase of 400 GbE over MMF uses 16 channels for transmission in both directions (total of 32 channels), each transmitting at 25 Gbps. To support this, TIA published a standard for 16- and 32-fibre MPO-style array connectors, ANSI/TIA-604-18 (FOCUS 18) at the end of 2015.

To provide a cost and performance migration path to 400 GbE, IEEE added support for two-channel 100 Gbps and four-channel 200 Gbps sometimes called NGOATH (Next Generation One and Two Hundred). Both of these are based on 50 Gbps channel rates. As a result, IEEE is also defining a single-channel 50 Gbps PHY with supported distances of at least 100 m over multimode fibre along with 2 km and 10 km options over singlemode fibre.

This two-channel 100 GbE will be supported over multimode fibre up to at least 100 m and up to at least 500 m over singlemode fibre. 200 GbE will be supported over multimode fibre at least 100 m, also. There will be several singlemode options including supporting a distance of at least 500 m using 4-channel parallel singlemode fibre (four parallel fibres), supporting a distance of at least 2 km over duplex singlemode fibre and supporting a distance of at least 10 km over duplex singlemode fibre.

The wideband MMF TIA standard was approved for publication in the middle of 2016. The standard specifies high bandwidth 50  $\mu$ m core diameter/125  $\mu$ m cladding diameter, laser-optimised optical fibre that is optimised to enhance performance for single wavelength or multi-wavelength transmission systems with wavelengths in the vicinity of 850 nm to 950 nm. The actual operating band is from 850 nm to 953 nm. The effective modal



bandwidth (EMB) for this new fibre is specified at the lower and upper wavelengths: 4700 MHz•km at 850 nm and 2470 MHz•km at 953 nm. ISO/IEC has assigned the OM5 designation for this type of fibre.

This is a significant standard for multimode fibre because it makes wavelength division multiplexing (WDM) possible over multimode fibre. Since the fibre is optimised for short wavelengths, the wavelength division multiplexing used over multimode fibre is commonly called short wavelength division multiplexing (SWDM). Up until now, WDM has only been used with singlemode fibre. WDM is important because it is one of four ways to increase the data rate: WDM, parallel transmission with multiple fibres, increased modulation and using multi-level coding.

To show how this new standard can influence fibre optic plant for current and in-progress Ethernet standards refer to Table 8. The current 40 GbE (40GBASE-SR4) standard, using short wavelength over multimode fibre (MMF), uses a channel rate of 10 Gbps with eight fibres; four fibres for transmission and four fibres for reception. Using WBMMF that supports four wavelengths (in effect four channels) the four transmit fibres are reduced to one fibre, as are the receive fibres. The fibre optic cable plant is reduced from eight fibres to two. 100GbE is an even better example because the original standard released in 2010 (100GBASE-SR10) required a total of 20 fibres, 10 transmit and 10 receive, using a 10Gbps channel rate. A new 100GbE standard (100GBASE-SR4) was published in 2015 specifying a 25Gbps channel rate which allowed the fibre count to be reduced to a total of eight fibres; the same fibre count as 40GbE. This is an example of how increased modulation reduces the fibre count. Using SWDM with the new WBMMF will reduce the fibre optic plant to two fibres for 100 GbE using a 25 Gbps channel rate. Both 40 GbE and 100 GbE are reduced to duplex transmission.

As was mentioned, Phase I of the 400GbE (IEEE 802.3bs) standard will specify transmission over multimode using parallel transmission with a channel rate of 25 Gbps. This will require a total of 32 fibres. Employing SWDM over WBMMF reduces the fibre count to 8 fibres, 25% of the number of fibres required in Phase I.

There are also many developments within Fibre Channel, a high-speed network technology primarily used to connect computer data storage. 32G Fibre Channel (GFC) was published and transceivers have been trialled since the 3rd quarter of 2016. The target link distance is 100 m over OM4 and 70 m over OM3. 32 GFC still uses serial transmission with 2 fibres and will use the same external small form factor pluggable (SFP) transceiver modules with LC fibre optic connectors. This will be backwards-compatible with 8 GFC and 16 GFC. There is a new project looking at 128 GFC. Normally, Fibre Channel doubles in speed, 8 GFC, 16 GFC, 32 GFC, etc., but 128 GFC will be based on 32 GFC. 128 GFC will use 4 x 32 GFC. A

port will be able to auto-negotiate 128 GFC back to 32 GFC and 16 GFC without user intervention.

There are ongoing discussions to combine both 64 GFC and 256 GFC. Having a SWDM MMF option, based on Wide Band MMF TIA-492AAAE, is also being considered. Requirements will include backwards compatibility with 32 GFC.

## Conclusions

Before selecting a product for your data center design, establish the fastest application your structured cabling will need to support. Multimode fibre systems are more common than singlemode systems for short distances because they are more cost-effective. Select at least OM3, however OM4 will provide longer-distance support or more connections over shorter distances. Some newer applications are supported up to 100 m only by OM4, so be aware of the application and distance requirements.

Wideband multimode fibre will have a huge influence on the fibre optic cable plant. As long as transceivers are available, two fibres can support up to 100 GbE using duplex transmission. If a transceiver can support 50 Gbps per channel using SWDM over wideband fibre, even the new 200 GbE could use duplex transmission (2 fibres in total). Wideband multimode fibre requires 25% of the total number of OM4 fibres to support applications traditionally using parallel transmission (multiple transmit and multiple receive fibres).

The type of connector is determined by the transmission; LC for duplex transmission and MPO/MTP® for parallel transmission. Channel insertion loss is the foundation for design, so consider high-performance, low-loss components.

You will also need to consider the polarity method to be used and then select the correct components to support that method. If using array connectors for parallel transmission, consider which components require pins and which do not. The best option is to work with the manufacturer to make sure the correct components are selected.

Don't forget to put as much thought into designing your physical infrastructure as the structured cabling. The connection density in switches, servers and routers is increasing. This means more cable to manage and higher operating temperatures, making properly managed airflow extremely important. The correct infrastructure design is critical to extend the life of the network and protect your investment.

# CPR – Construction Products Regulation

The aim of the CPR regulation is to guarantee the free circulation of products made in the European Union, adopting a harmonised technical language which can define the performance and essential features of all construction products.

Electrical cables are rarely the cause of a fire but when they are involved they may form a seriously hazardous component because of their large quantities and because they are found in all rooms of the building. With careful prevention and making state-of-the-art systems with safe and high-quality components in accordance with the CPR regulation, fire propagation, the lack of visibility in smoke-filled rooms and the diffusion of corrosive and toxic gases can be reduced or almost totally eliminated.

The CPR regulation (EU 305/2011) concerns all the products made to be permanently incorporated (installed/used) in buildings and other civil engineering works (e.g. homes, industrial and commercial buildings, offices, hospitals, schools, undergrounds, etc.). As part of the features considered important for the safety of constructions included in the CPR, the European Commission has decided to consider cables' Reaction to Fire and Resistance to Fire, recognising the importance of their behaviour and role in fire. The release of harmful substances is one of the performances considered important for cables, although at present no minimum levels of performance have been established because when used normally the cables do not release harmful substances.

All the cables installed permanently in constructions, to transport power or for telecommunications, of any voltage level and with copper or fibre optic conductors, must be classified on the basis of the classes of premises where they will be installed.

**The cables are classified in 7 classes of Reaction to Fire: Aca, B1ca, B2ca, Cca, Dca, Eca and Fca** identified by the subscript "ca" (cable) as a function of their decreasing performance. As well as this main classification, the European authorities have also regulated the use of the following additional parameters:

- **a** = acidity which defines the hazard of the fumes for people and the corrosiveness for things. Varies from a1 to a3
- **s** = opaqueness of the smoke. Varies from s1 to s3
- **d** = dropping of incandescent particles which could propagate fire. Varies from d0 to d2.

A more severe check (System 1+) is required for the classes from Aca to Cca. It lays down the initial check and continuous monitoring of the product and checks of the manufacturing control system, while for the classes from Dca to Eca the check only lays down the initial product check (System 3). Class F, however, is based on the manufacturer's self-declaration (System 4).

The table below contains the classification of cables according to the test requirements of the CPR Regulation and the correlation between the cable classification and the most representative installation rooms.

	Euroclass	Classification criteria	Additional criteria	AVCP system (Assessment and Verification of Consistency of Performance)	
<b>Non combustible</b> (e.g. mineral insulated)	<b>A<sub>ca</sub></b>	EN ISO 1716 Gross heat of combustion		"1+", including: <ul style="list-style-type: none"> <li>initial type-testing and <b>continuous surveillance</b></li> <li>Audit &amp; testing of samples <b>by 3rd-party certification body</b></li> </ul>	
<b>Low-Fire-Hazard cables</b> (various levels)	<b>B1<sub>ca</sub></b>	EN 50399 <b>Heat release</b> <b>Flame spread</b>	<b>Smoke production</b> {s1a, s1b, s2, s3} EN50399/EN61034-2  <b>Acidity</b> {a1, a2, a3} EN 50267-2-3  <b>Flaming droplets</b> {d0, d1, d2} EN 50399	Factory production controls by manufacturer	
	<b>B2<sub>ca</sub></b>				
	<b>C<sub>ca</sub></b>			EN 60332-1-2 <b>Flame propagation</b>	"3", including: <ul style="list-style-type: none"> <li>initial type-testing by 3rd-party laboratory</li> </ul>
	<b>D<sub>ca</sub></b>				
<b>Standard cables</b>	<b>E<sub>ca</sub></b>	EN 60332-1-2 <b>Flame propagation</b>		Factory production controls by manufacturer	
<b>No performance determined</b>	<b>F<sub>ca</sub></b>	EN 60332-1-2 <b>Flame propagation</b>		"4" initial type-testing and factory production controls by manufacturer	

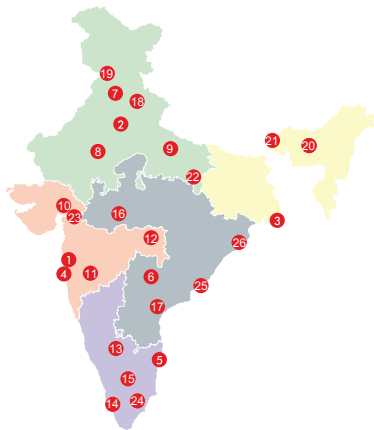

### Head office

- 61 & 62, 6th Floor,  
Kalpataru Square, Kondivita Road,  
Off Andheri-Kurla Road, Andheri (E),  
**MUMBAI** – 400 059.  
Tel : (022) 3041 6200  
Fax : (022) 3041 6201  
Website : [www.legrand.co.in](http://www.legrand.co.in)

### Regional sales offices

- A-25, Mohan Co-operative  
Industrial Estate, Mathura Road,  
**NEW DELHI** - 110 044.  
Tel : (011) 3990 2200, 2699 0046,  
(011) 2699 0028 / 29 / 30 / 31  
Fax : (011) 2699 0047
- Bhakta Towers, 2nd & 3rd Floor,  
Plot No. KB 22, Sector-III, Saltlake,  
**KOLKATA** – 700 098.  
Tel : (033) 4021 3535 / 36  
Fax : (033) 4021 3537
- C/203, Corporate Avenue, Atul Projects,  
Near Mirador Hotel, Chakala,  
Andheri Ghatkopar Link Road,  
Andheri – East, **MUMBAI** – 400 099.  
Tel : (022) 3385 6200
- 10 B, (10th Floor), Prestige Center Court  
Office Block Vijaya Forum Mall, #183,  
N.S.K. Salai, Vadapalani  
**CHENNAI** – 600 026.  
Tel : (044) 3024 7200 / 2362 3125 / 35 / 45  
Fax : (044) 2362 3165
- 205-208, 2nd Floor,  
Block - II, White House,  
Kundan Bagh, Begumpet,  
**HYDERABAD** – 500 016.  
Tel : (040) 2341 4398 / 67, 4567 1717  
Fax : (040) 4567 1730

### Branch offices

- SCO 1-2-3,  
Second Floor, Sector 17B,  
**CHANDIGARH** – 160 017.  
Tel : (0172) 305 8631 / 32 / 33 / 34 / 35  
Fax : (0172) 501 9008
- 507-510, Vth Floor, Soni Paris Point,  
Jai Singh Highway, Banipark,  
**JAIPUR** – 302 016.  
Telefax : (0141) 511 3129, 510 1179
- 209-A, 2nd Floor, Cyber Heights,  
Opp. Indira Gandhi Pratishthan,  
Vibhuti Khand, Gomti Nagar  
**LUCKNOW** – 226 010.  
Tel : (522) 319 2031 / 32 / 33
- A 101-102, Mondeal Heights,  
Besides Novotel Hotel,  
Sarkhej Gandhinagar Highway  
(S G Highway),  
**AHMEDABAD** – 380 015.  
Tel : (079) 6134 0555
- 402, Swastik Chambers,  
Near Ashwamegh Marriage Hall,  
Behind HP Petrol Pump,  
Off Karve Road, Erandwane,  
**PUNE** – 411 004.  
Tel : (020) 6729 5601 / 602  
Fax : (020) 6729 5604
- Plot No.95, II Floor, Shreyash Heights,  
VIP Road, Ramdaspath,  
**NAGPUR** – 440 010.  
Tel : (0712) 662 7857 / 858  
Fax : (0712) 662 7859
- 2nd Floor, Al' Latheef Building,  
2/1, Union Street, Off. Infantry Road,  
**BANGALORE** – 560 001.  
Tel : (080) 2286 1078, 4113 3293  
Fax : (080) 4113 3294
- J. B. Manjooran Estate,  
Door No 50/1107A9, 3rd Floor,  
Bye Pass Junction, Edappally,  
**COCHIN** – 682 024.  
Tel : (0484) 280 1921 / 2921, 658 0921  
Fax : (0484) 280 1921 / 2921
- B-5, 1st Floor, Thirumalai Towers,  
723, Avanashi Road,  
**COIMBATORE** – 641 018.  
Tel : (0422) 650 2728, 222 3634 / 0283  
Fax : (0422) 222 3164
- 204-205, Megapolis Square,  
579, M G Road,  
**INDORE** – 452 001.  
Tel : (0731) 393 1650 / 51 / 52  
Fax : (0731) 393 1653
- MF-2, Datta's Lords House,  
Jammi Chettu Street, Mogalrajapuram,  
**VIJAYAWADA** – 520 010.  
Tel : (0866) 661 1393, 664 6393  
Fax : (0866) 669 9393

### Area offices

- ABC Business Club 16,  
Tagore Villa,  
**DEHRADUN** – 248 001.  
Tel : (0135) 271 5189  
Fax : (0135) 271 5580
- Cabin No. 9,  
Second Floor,  
Madhok Trade Centre,  
Madhok Complex,  
Ferozpur Road,  
**LUDHIANA** – 141 001.  
Tel : (0161) 277 0301 / 2 / 3 / 4
- House No. 97,  
Ground Floor,  
Rajgarh Main Road,  
Opp. City Heart Nursing Home,  
**GUWAHATI** – 781 007.  
Tel : (0361) 245 8498
- 94, Udham Singh Sarani,  
Ground Floor, Ashrampara,  
**SILIGURI** – 734 001.  
Tel : (0353) 264 1067
- 202 & 203, 2nd Floor,  
Sunrise, Forum 100,  
Burdwan Compound, Lalpur,  
**RANCHI** - 834 001.  
Tel : +91 9088104858
- 405, City Centre, Sosyo Circle,  
Udhana Magdalla Road,  
**SURAT** - 395 002.  
Tel : (0261) 263 3861
- Aparna Towers, 1st Floor,  
2/3, Bypass Road,  
**MADURAI** – 625 010.  
Telefax : (0452) 230 8414
- 404, Eshwar Plaza,  
Dwaraka Nagar, Main Road,  
Beside Bata Show Room,  
**VISHAKHAPATNAM** – 530 016.  
Tel : (0891) 663 5652  
Fax : (0891) 663 9363
- Plot No. 359,  
Saheed Nagar, 2nd Floor,  
**BHUBANESWAR** – 751 007.  
Tel : (0674) 254 0623

### Technical assistance from Legrand

Telephonic technical assistance for selection of products, technical information, guidance, wiring diagrams and estimation is now made available to you at each Regional Office. Contact the Technical Officer of Legrand at the following telephone numbers

- New Delhi** : Tel.: (011) 2699 0028, 3990 2200  
**Kolkata** : Tel.: (033) 4021 3535 / 36  
**Mumbai** : Tel.: (022) 3385 6200  
**Chennai** : Tel.: (044) 3024 7200  
**Hyderabad** : Tel.: (040) 2341 4398 / 67, 4567 1717

For other places, contact the nearest  
Regional / Branch / Area offices

[customer.care@legrand.co.in](mailto:customer.care@legrand.co.in)

